

VIGAS

Gasifying boilers

MANUAL FOR INSTALLATION, ASSEMBLY,
MAINTENANCE AND USE

Warranty Certificate

VIGAS and VIGAS Lambda Control
with **AK 4000** control



**ECO
DESIGN
2020**

VIMAR 2024 (Original)
Ver.D 3.00

Content	Page
Declaration of conformity.....	3
1. Technical description.....	4
2. Technical data.....	5
3. AK 4000 control description.....	7
4. VIGAS boiler - basic configuration.....	9
5. VIGAS boiler - discharge fan configuration.....	10
6. VIGAS <small>Lambda Control</small> – basic configuration.....	11
7. Kotel VIGAS <small>Lambda Control</small> - discharge fan configuration.....	13
8. Temperature setting.....	14
9. Parametres setting.....	15
10. Time set-up.....	16
11. Harware and software information.....	16
12. Error notification.....	16
13. Configuration setting using PIN 0000.....	17
14. Operating instructions.....	22
15. Boiler maintenance and repairs.....	24
16. Boiler accessories and assembly.....	26
17. Service departments.....	27
18. Problems, cause and solution.....	28
19. Transport, handling, assembly and installation.....	30
20. Electric schema.....	33
21. Analysis of risk.....	34
VIGAS Warranty certificate.....	37
VIGAS Commission certificate	38



DECLARATION OF CONFORMITY

Original

Issued according to Act. No. 56/2018 Coll
a 97 / 23 EC

We, Pavel Vigaš - VIMAR,

M. Čulena 25
974 11 Banská Bystrica
SLOVAKIA
VAT no. SK1020548001
REG no. 17956145

It is hereby declared that the undermentioned products comply with technical regulations and the products are safe if predetermined guidelines are followed. All possible measures have been taken to assure the compliance of products together with technical documentation are within specification and legal requirements. The validity of this statement is void if unauthorized changes are made without permission of VIMAR.

Product: Thermal boiler VIGAS a VIGAS Lambda Control with AK4000 control

Type: VIGAS 16, VIGAS 16 Lambda Control , VIGAS 25, VIGAS 25 Lambda Control
VIGAS 40, VIGAS 40 Lambda Control , VIGAS 60, VIGAS 60 Lambda Control
VIGAS 80, VIGAS 80 Lambda Control , VIGAS 100, VIGAS 100 Lambda Control

Producer: Pavel Vigaš - VIMAR
M. Čulena 25, 974 11 Banská Bystrica,
SLOVAKIA

Competent statutory codes (CSC)

97/23/EC	Pressure equipment Directive
2014/30/EC	Electromagnetic Compatibility Directive (EMC)
2014/35/EC	Directive concerning electrical equipment intended for use within certain voltage limits
2014/68/EU	Directive relating to making available on the market of pressure equipment
2011/65/EU	Directive RoHS
2006/42/ES	Machinery Directive
2009/125/ES	Directive on ecodesign requirements for energy - related products

Used harmonized standards for CE marking

STN EN 303-5:+A1 2023; STN EN 60335-1: 2012; STN EN 60335-2-102: 2016
STN EN 61000-6-2:2019, STN EN 55014-1:2017; STN EN 61000-6-3: 2007, STN EN ISO 14120: 2016, STN EN ISO 12100: 2011

Additional data:

Design Examination Certificate no. 812990017, Certificate no. 812990019,
Certificate no.101299028, Certificate no.0069/104/2022, Certificate no.0070/104/2022,
Certificate no.0053/104/2022, Certificate no.E381122-ISO 14001:2016, Certificate no.
S381122-ISO 45001:2018, Certificate no.Q381122-ISO 9001:2016.

Issued in: Banská Bystrica

Name: VIGAŠ Pavel

Date of issue: 01.04.2023

Title: Owner

Signature:

1. TECHNICAL DESCRIPTION

VIGAS thermal boilers are designed for the combustion of dry wood materials, using sawdust to wood logs according to the dimensions of the gasification chamber, with a maximum diameter of 20 cm. Sawdust, woodchips, splinters and cuttings must be burned in conjunction with wood logs. It is possible to use dry wooden material as a substitute fuel.

Boilers are welded from 4 – 6 mm steel sheets. Inner boiler sheets, which are in contact with boiler waste gases, are 6 mm thick, others are made of 4 mm steel.

The heat exchanger is welded from steel pipes, 57x4,5 mm. Exterior boiler panels are made of 0,8 mm sheet. Thermal insulation of the boiler is made of insulation material, NOBASIL 20 and 50 mm thickness. Combustion gases pass through the steel boiler neck to the chimney.

The boiler space consists of a combustion chamber, where fuel is dried and gasified. Then accrued gases pass through the fireproof concrete nozzle or a cast iron nozzle into the combustion chamber, where it burns with the help of secondary air. Flue gases are intensively cooled in the exchanger. The boiler has a light up damper controlled by a lever at the front of the boiler.

In order that the boiler complies with the requirements for non-demanding operations, it is equipped with an AK4000 control located on the top panel of the boiler. The design of the system allows very effective combustion of various kinds of fuel. The AK4000 Control with graphical display in basic configuration offers the following:

- controlled temperature of heated water ranging from 70 - 85°C (up to 90°C with accu. tank)
- continuous and automatic control of the fan according to required output and type of fuel
- connection to and control of discharge fan
- connection to and control of circulation pump
- connection to the gases thermometer
- connection to room thermostat (room temperature regulator is voltage free)
- connection to extended regulation (Expander AK 4000) via BH BUS
- connection to module AK 4000M data back-up, followed by PC evaluation
- graphical schematic indicating hydraulic boiler connection as requested
- real time set

Configuration VIGAS Lambda Control offers :

- control of the servo flap of primary and secondary air, based on data received from the lambda sensor oxygen level reading.
- during a power cut, AA batteries will close the servo-operated flap and this prevents draught from the chimney burning up the fuel.

The boilers are equipped with a STB thermal fuse, which disconnects the boiler fan if overheating occurs (above 100°C). A safety mechanism to prevent the boiler from overheating is a requirement of the STN EN 303-5:+A1 2023 standard. It is recommended to install a safety valve TS 131 ¾" in the exchanger to avoid overheating.

1.1 WASTE DISPOSAL

Packaging material (wood, polystyrene, stretchfoil). Wood can be burned in the boiler, polystyrene and stretchfoil deliver to the separate waste collection. After the end of the lifetime of the boiler, the boilerbody and cover panels must be disposed as metal waste. Insulating material muss be delivered to the separate waste collection. Used packaging materials fulfill the conditions for placing the packaging materials on the market.

2. TECHNICAL DATA

Chart.1

THERMAL BOILERS														
VIGAS		16	16 LC	25	25 LC	40	40 LC	60	60 LC	80	80 LC	100	100 LC	UD 29
Energy efficiency class		A+	A+	A+	A+	A+	A+	A+	A+	A+	A+	A+	A+	A+
Nominal boiler output	kW	16		25		40		60		80		100		29
Boiler ecodesign requirements CR (EU) 2015/1189		☑												-
Boiler class acc. to EN 303-5: 2023		5												3
Max. operating pressure	bar	3												
Fuel		Wood, max. moisture 20% of heat value min. 15 MJ/kg												Brown coal
Output capacity	kW	8 - 18		8 - 31		14 - 41		15 - 72		25 - 92		25-100		8-35(8-29)*
Fuel consumption with nominal output	kg/hrs.	4,2	4,1	6,6	6,5	10,5	10,3	16,1	15,7	21,4	20,8	26,7	26,0	7,8 (8,0)*
Alternative fuel		wood waste, wood chips, sawdust, sawdust briquettes,												
Chimney draught	mBar	0,10-0,20		0,15-0,25		0,20 - 0,30		0,25 - 0,35		0,25 - 0,35		0,15 - 0,25		
Weight	kg	400		430		460		760		930		950		430
Height with control	A mm	1135		1385		1420		1120		1120		1120		
Height of outlet branch	B mm	1075		1310		1370		1045		1045		1045		
Height of inlet branch	C mm	115		125		215		110		110		110		
Height of water-feed valve	D mm	55		70		135		55		55		55		
Height of chimney outlet	E mm	890		1110		1160		890		890		890		
Width including lever	F mm	645		645		795		645		645		645		
Width including panels	G mm	590		590		760		590		590		590		
Depth	H mm	840	1070		1260		1690		1070		1070		1070	
Exhaust brand	I mm	240		545		240		240		240		240		
Diameter of chimney outlet	J mm	Ø 160		Ø 196		Ø 160		Ø 160		Ø 160		Ø 160		
Depth from edge	K mm	188	305		880		1210		218		218		218	
Spacing of insert	L mm	405		70		350		350		350		350		
Diameter of inlet brand	G	2"		2"		2"		2"		2"		2"		
Diameter of outlet brand	G	2"		2"		2"		2"		2"		2"		
Diameter of water-feed valve	G	1/2"		3/4"		1/2"		1/2"		1/2"		1/2"		
Water volume	l	60	75	93	180	205	215	75	75	75	75	75	75	75
Gas temperature:														
Nominal output	°C	240												
Minimum output	°C	150												
Gasification chamber dimension - Depth	mm	400	570		750		1150		1090		490/440		490/440	
Height	mm	500		750		730		500		500		500		
Width	mm	380		440		575		440		440		440		
Gasification chamber dimension (w-h)	mm	435 -255		575 - 318		435 - 255		435 - 255		435 - 255		435 - 255		
Max. fuel weight	kg	20	35	55	95	150	140	30	30	30	30	30	30	30
Capacity of chamber	dm ³	80	120	185	315	483	457	105	105	105	105	105	105	105
Noise level	dB	45	45,5	47,7	51,4	54,2	45,5	45,5	45,5	45,5	45,5	45,5	45,5	45,5
Max. electric input	W	13,8	25,1	21,9	32,9	34,4	45,9	48,8	60,0	62,1	73,2	142,0	153,8	21,9
Voltage/ frequency	V/Hz	230ACV / 50 Hz												
Pressure loss of water :														
Δt 10 °C	mBar	9,70	9,75	10,48	12,77	11,83	11,53	9,97	9,97	9,97	9,97	9,97	9,97	9,97
Δt 20 °C	mBar	1,00	1,05	2,55	3,19	2,96	2,84	1,15	1,15	1,15	1,15	1,15	1,15	1,15
Heat Exchanger														
- inlet water temperature	°C	4 - 15												
- inlet water pressure	bar	min 1 - max 4												
Safety		Drain valve for heat exchanger HONEYWELL TS 131 3/4"												
		Opening temperature 95 °C												
		STB fuse, blow temperature 100°C (tolerance: -6 °C - 0 °C)												
Weight flow of gases	kg/s	0,034 - 0,047												

* specification for wood fuels

2.1 DIMENSION CHART AND THE POSITION OF SAFETY PLATE TO ENSURE PROTECTION OF INFLAMMABLE FLOORING

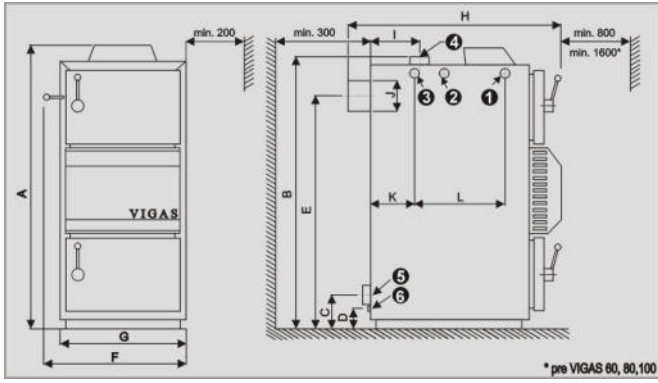

- ❶ Inlet brand for drain valve
- ❷ Hole for down valve insert
- ❸ Outlet brand of cooling water 3/4"
- ❹ Outlet brand of hot water
- ❺ Inlet brand of reverse water
- ❻ Water filling valve

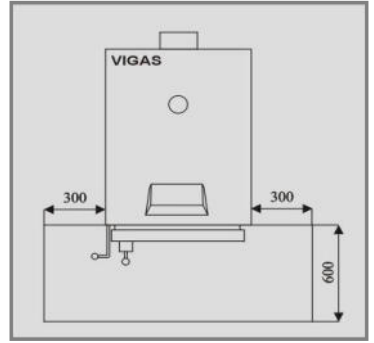

2.2 BOILER SCHEMATICS

Schematic VIGAS 16

Pic. 3

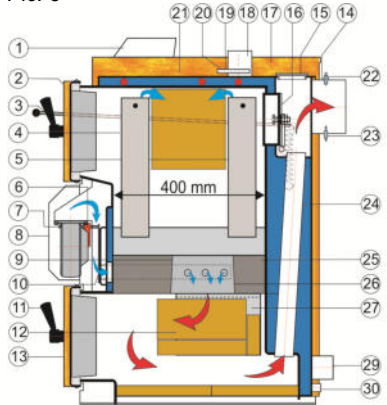

Schematic VIGAS 25

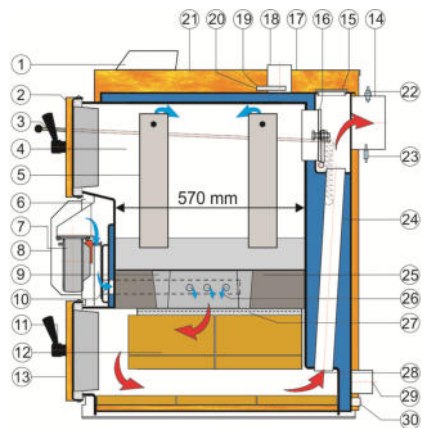

Schematic VIGAS 40

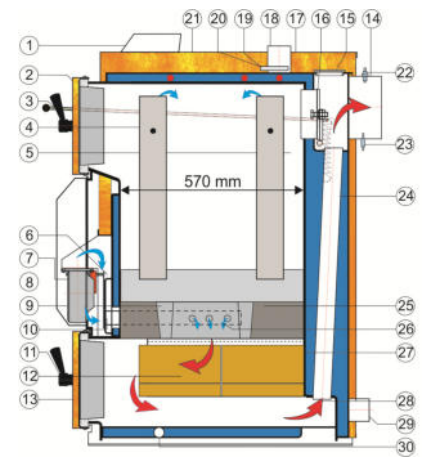

Schematic VIGAS 60,80

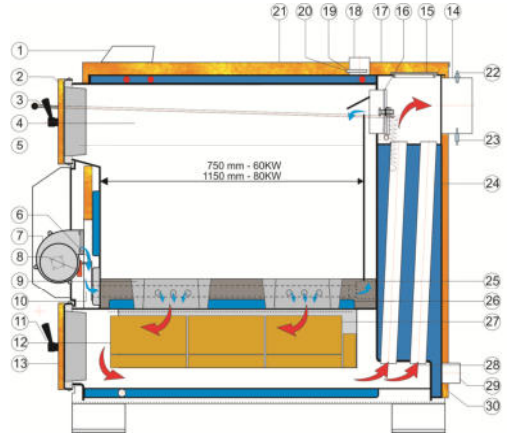

Schematic VIGAS 100

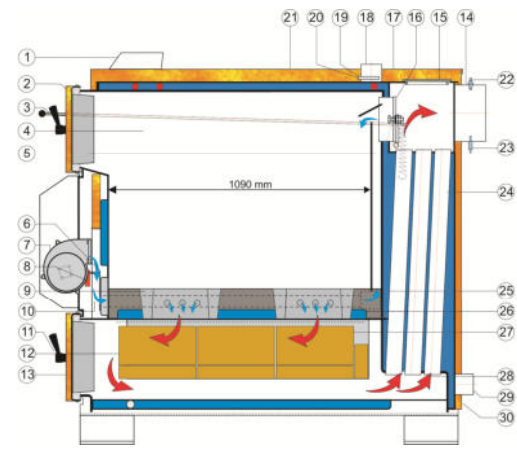

KEY:		
1. Control AK4000	11. Handle	22. Lambda sonda
2. Upper door	12. Fireclay bricks	23. Gases thermometer
3. Chimney flap operating rod	13. Bottom door	24. Exchanger pipes
4. Chamber area	14. Chimney output	25. Heat proof/concrete filling
5. Primary air conduction	15. Exchanger cover	26. Secondary air
6. Flap for servo Belimo	16. Light up flap	27. Combustion chamber
7. Fan	17. Upper back panel	28. Gases direction
8. Fan cover	18. Water outlet	29. Reverse water leak
9. Nozzle	19. Thermal fuse	30. Filling leak
10. Secondary air flap	20. Thermometer	

3. DESCRIPTION OF AK4000 CONTROL

3.1 SAFETY INSTRUCTIONS

- Please check the protective cover panels before you plug-in the power lead
- Avoid any contact of the power lead with hot parts of the boiler (e.g. smoke flue).
- Make sure that upper insulation under the panel remains dry (risk of short circuit if damp)
- Do not put any stress on power lead.
- Always disconnect the power lead when new electrical components are being connected to the boiler (eg indoor room thermostat, discharge fan, circulation pump...)
- Do not remove the protective cover panels, and particularly the fan cover panel, when the boiler is in operation.
- Check if the voltage displayed on the label is same as your distribution network.
- Always keep to the terms of use

3.2 CONNECTION TO THE POWER SUPPLY

AK 4000 Control is an integral part of VIGAS boilers.

The control is connected when the power lead is plugged into a 220/230V power supply. The visual display with basic image is active when the power lead is plugged-in (pic.4). Servo-flap used in VIGAS Lambda Control is set to basic position (pic.5).

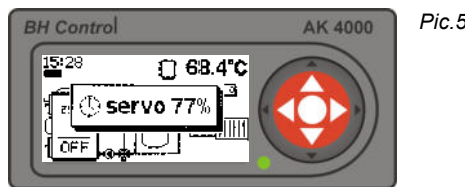
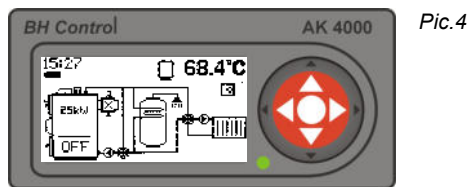

3.3 SERVICE CONDITIONS

AK4000 Control is designed for operation within a temperature range from +5°C up to +45°C. The Control cannot be used in a moist environment or in direct sunlight.

3.4 MAINTENANCE OF AK4000 CONTROL

Keep in a clean and dust free environment. Anti-static cloths or wet wipes are recommended to wipe-off dust and impurities from metal covers and the control panel.

3.5 CONTROL PANEL

Part of the electronic control panel is equipped with buttons, visual display and schematics. Further information is available in the following sections of this manual.

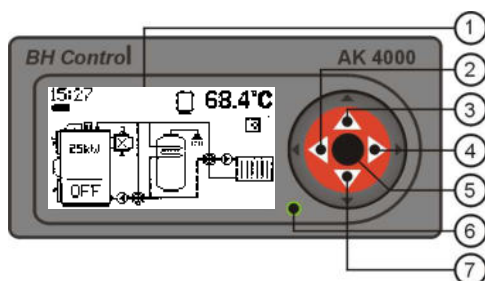

pic.6

1. Graphic display 128 x 64 pix.
2. Button ◀ with functions, ENTER
3. Button ▲ with functions
4. Button ▶ with functions, EXIT (ESC)
5. Button ● (ENTER) with functions
6. LED control (green - OK, red - ERROR)
7. Button ▼ switch functions

Graphic information

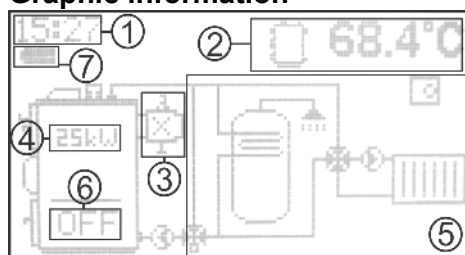

pic.7



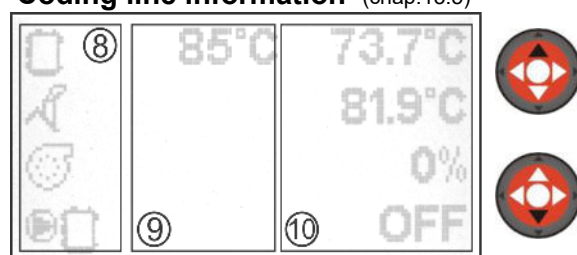



























Coding line information (chap.13.5)

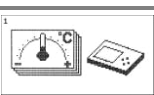
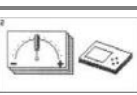
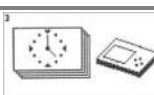
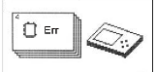

Gasifying boiler VIGAS

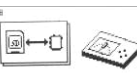
1. Real time indication
2. Coding line – indication of current boiler figures
Modification ▲ or ▼
3. Indication of discharge fan, lambda sensor, gas thermometer
4. Indication of nominal output when boiler is switched off.
5. Graphic indication of hydraulic connection schematic.
6. Boiler status indication
7. Battery condition (2 units type AA) used to close servo-flap (only VIGAS Lambda Control)
8. Symbols
9. Set figures
10. Current figures

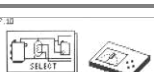
3.6 SYMBOLICS

Boiler		Accumulator tank		External boiler	
Boiler „ON“	ON	DUOMIX		Heating Circuit	
Boiler „OFF“	OFF	Valve with servomotor		Indoor thermostat	
Flame up	 ON	Pump		3-way thermostatic valve	
Burning	 73 °C	Discharge fan		LADOMAT	
Afterflaming	 52 °C	Lambda	λ	Fan	
End of burning	END	Thermometer	T	Fan change output	
		External thermometer		Floor heating	
Boiler attenuation		Indication figure error	X	Servo-flap position	 servo 50%
Add fuel		Shut-down temperature	 end	Max. exhaust gas figures	 max
Temperature set up		Parameters set up		Time set up	
Error notifications		Programm		Configuration data	
Servise set ups		Memory modul		Motion regulation	
Schemas option		Installation data		Indication option	

4. BASIC CONFIGURATION OF VIGAS BOILER WITHOUT EXHAUST FAN

The advantage of the exhaust gas thermometer is to control the maximum exhaust gas temperature, and when this is reached by the boiler, a fan will come into operation to lower the engine RPM. This results in higher boiler efficiency and lower fuel consumption. If installed with an accumulator tank, the thermometer will shut down the boiler when fuel is burned down. The water temperature inside the boiler and accumulator tank has no influence on boiler shut down.

4.1 VIGAS BOILER CONTROL

4.1.1 Boiler activation

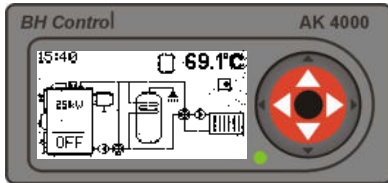

OFF will be displayed when the boiler is switched off. To START the boiler press middle button ENTER.

4.1.2 Boiler active – heating phase, heating regime „On“

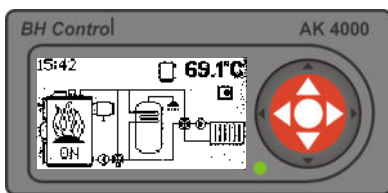

In the heating phase, the boiler gas exhaust temperature is lower than the minimum set-up exhaust gas temperature. Minimum and maximum temperatures can be modified in boiler set-up parameters. Minimum standard exhaust gas set-up temperature is up to 90°C and maximum set-up temperature is 220°C. Boiler can be in heating mode for up to 60 minutes with a minimum of 2min. If boiler does not reach burning phase in this time, it will automatically shut down – sign „END“.

4.1.3 Boiler active – burning phase „74°C“

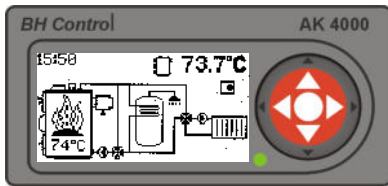

The burning phase is active, when the exhaust gas temperature is (end) +10 °C or after reaching desired temp. Burning phase is controlled by PID regulator on the basis of chimney and boiler temp. If the temperature rises 1°C above desired temp., the output will be 0%. If it decreases >2°C below desired temp., the output will start again.

4.1.4 To add fuel or boiler shut-down (manual control)

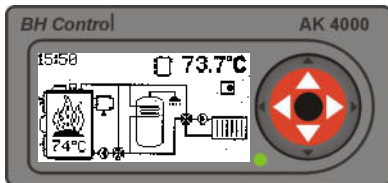

Graphic control is used for this operation. To activate display driver press middle button „ENTER“. Graphic control offers options: switch-off boiler, add fuel or cancel display driver.

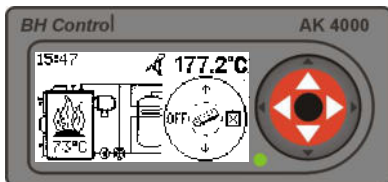

Choose one option	
OFF	Switch off
	Add boiler
<input checked="" type="checkbox"/>	Cancel display driver
	Change indicated figure

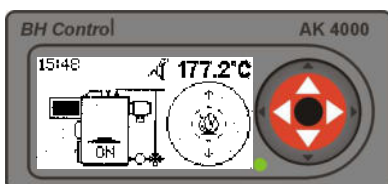
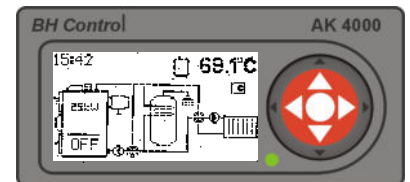

By pressing fan will be switched off. Use lever to open chimney flap and consequently open the upper door. Fuel can be added if necessary. After reloading close the upper door and chimney flap (pic.12.4). By pressing refuelling will be ended. Fan will switch on automatically.

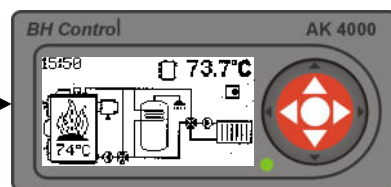
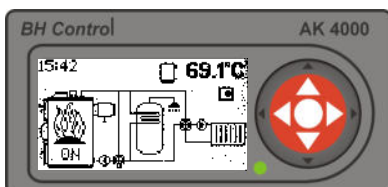

4.1.5 Boiler shut-down (automatic)

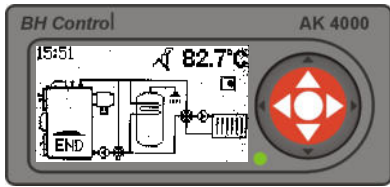

When exhaust gas temperature drops under the set-up temperature (end), the boiler is automatically switched-off. Sign „END“ will be indicated on the display. By pressing the „ENTER“ button twice the boiler will start-up again.

5. VIGAS BOILER CONFIGURED WITH DISCHARGE FAN (without lambda sensor)

The advantage of a discharge fan installation is increased comfort during boiler open burn and refuelling stages. The discharge fan helps to significantly reduce flue gas and smoke escape in the surrounding area during the refuelling stage. The discharge fan helps to quickly start the fire.

5.1 VIGAS BOILER CONTROL

5.1.1 Boiler activation

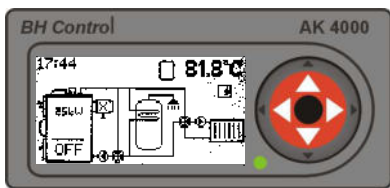

If the boiler is in shut-down phase, with symbol „OFF“ on the display, to start-up press middle „ENTER“ button.

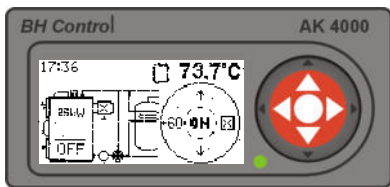

Choose one option	
+60	To start discharge fan for 60 secs (use with open burn phase)
ON	Switch on
<input checked="" type="checkbox"/>	Cancel display driver
▲ ▼	Change indicated figure

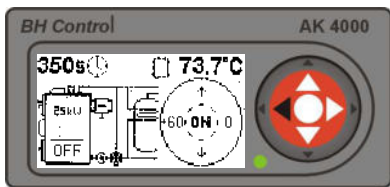

Select „+60“ new graphic drive will appear. Running time of discharge fan is located in the left upper corner of the display.	
+60	You can add an extra 60 secs – to a maximum 300 secs
ON	Switch on
0	Discharge fan switched-off
▲ ▼	Change indicated figure

5.1.2 Boiler active – heating phase „ON“

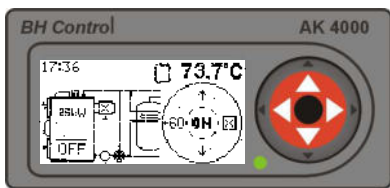

In the heating phase, the boiler gas exhaust temperature is lower then the minimum set-up exhaust gas temperature. Minimum and maximum temperatures can be modified in boiler set-up parameters. Minimum standard exhaust gas set-up temperature is up 90°C and maximum set-up temperature is 220°C. Boiler can be in heating mode for up to 60 minutes with minimum of 2min. If boiler does not reach burning phase in this time, it will automatically shut down – sign „END“.

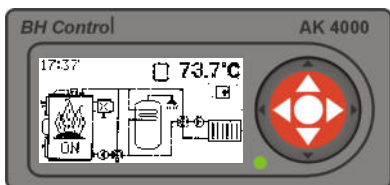

5.1.3 Boiler active – burning phase „82°C“

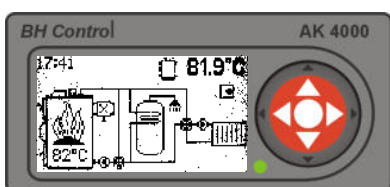

The burning phase is active, when the exhaust gas temperature is (end) +10 °C or after reaching desired temp. Burning phase is controlled by PID regulator on the basis of chimney and boiler temp. If the temperature rises 1°C above desired temp., the output will be 0%. If it decreases >2°C below desired temp., the output will start again.

5.1.4 Add fuel, boiler shut-down (manual control)

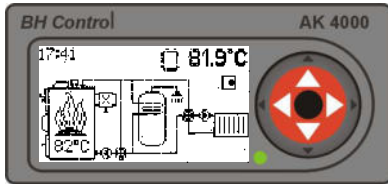

The graphic control is used for this operation. To activate display driver press middle „ENTER“ button. The graphic control offers option to: switch-off boiler, add fuel or cancel display driver.

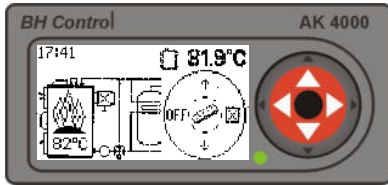

Choose one option	
OFF	Switch off
	Add fuel
<input checked="" type="checkbox"/>	Cancel display driver
	Change indicated figure

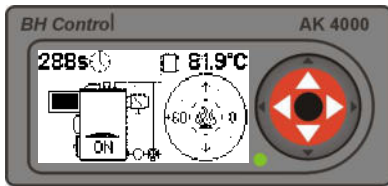
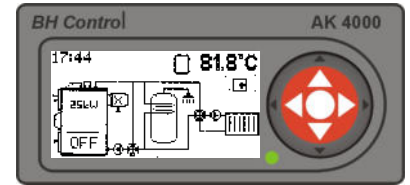

By pressing „“ , the boiler fan will be switched-off and the discharge fan will be switched-on between 60 secs and maximum 300 secs. The time is indicated in the upper left hand corner of the display. By pressing button „+60“ it is possible to extend discharge fan running time. Using the lever, open chimney flap and consequently open the upper door. You can add fuel if necessary.

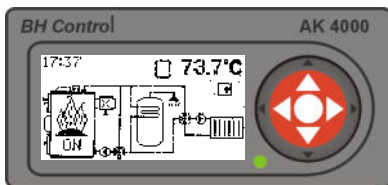

After fuel reloading close the upper door and chimney flap (pic.12.4). By pressing „0“ the discharge fan will be switched off, boiler fan will start working automatically.

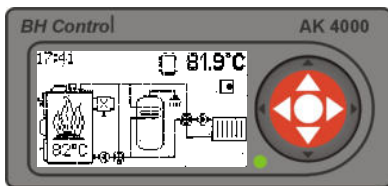

5.1.5 Boiler shut-down (automatic)

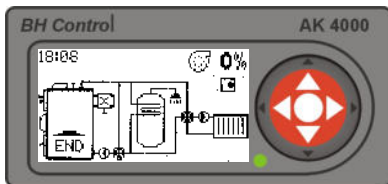

When exhaust gas temperature drops under the set-up temperature (end), the boiler is automatically switched-off. Sign „END“ will be indicated on the display. By pressing the „ENTER“ button twice, the boiler will start operating again.

6. BOILER VIGAS Lambda Control IN BASIC CONFIGURATION WITHOUT EXHAUST FAN

Boiler VIGAS Lambda Control operates using information about the oxygen in the exhaust gas received from lambda sensor to control the flap of primary and secondary air. This system allows burning of all types of wood more efficiently and at the same time decrease the fuel consumption by 20-25 %.

6.1 VIGAS Lambda Control BOILER CONTROL

6.1.1 Boiler activation

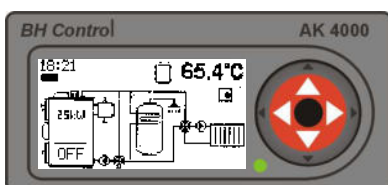

If the boiler is in shut-down phase, with symbol „OFF“ on the display, to start-up press middle „ENTER“ button.

6.1.2 Boiler active – heating phase „On“

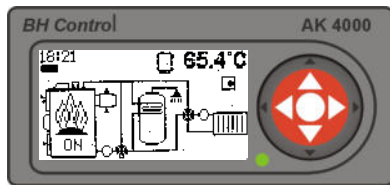

The servo-controlled flap will move to open position (servo 100%) when „ENTER“ button is pressed. Consequently, the following sequence 100% down to 45% will move the flap to retain the lambda sensor value of λ 1,35. When displaying servo at 45%, secondary air is closed. When displaying 0% primary air is also closed. The flap will move to position 0% only when boiler is in the „OFF“ or „END“ phase.

In the heating phase, the boiler gas exhaust temperature is lower then the minimum set-up exhaust gas temperature. Minimum and maximum temperatures can be modified in boiler set-up parameters. Minimum standard exhaust gas set-up temperature is up 90°C and maximum set-up temperature is 220°C. Boiler can be in heating mode for up to 60 minutes with minimum of 2min. If boiler does not reach burning phase in this time, it will automatically shut down – sign „END“.

6.1.3 Boiler active – burning phase

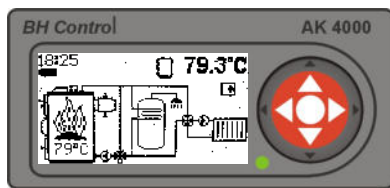

The burning phase is active, when the exhaust gas temperature is (📈 end) +10 °C or after reaching desired temp. Burning phase is controlled by PID regulator on the basis of chimney and boiler temp. If the temperature rises 1°C above desired temp., the output will be 0%. If it decreases >2°C below desired temp., the output will start again.

6.1.4 Add fuel, boiler shut-down (manual control)

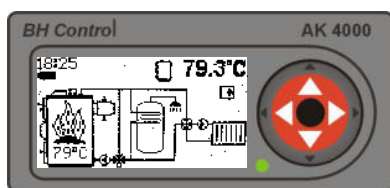

The visual graphic control is used for this operation. To activate the display driver, press small middle button ENTER. The graphic control offers options: switch-off boiler, add fuel or cancel display driver.

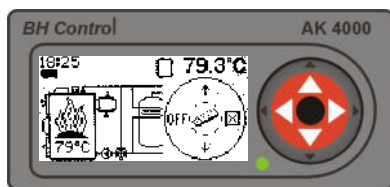

Choose one option	
OFF	Switch off
📝	Add fuel
<input checked="" type="checkbox"/>	Cancel display driver
▲ ▼	Change indicated figure

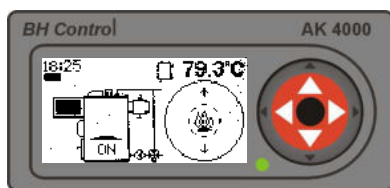
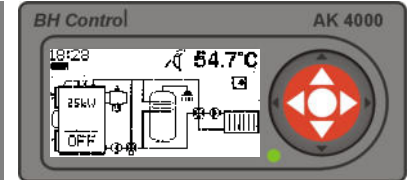

By pressing „📝“ the boiler fan is switched off. Open chimney flap and upper door. Add fuel as necessary. After that, close upper door and chimney flap. By pressing „🔥“ finishes fuel reloading and the fan will be switched on. During fuel reloading, the servo-controlled flap remains in the same position as it was before adding fuel. When fuel reloading is complete, the flap moves to the position (servo 100%). Consequently, the following sequence 100% down to 45% will move the flap to retain the lambda sensor value of λ 1,35. When displaying servo at 45%, secondary air is closed. When displaying 0% primary air is also closed. The flap will move to position 0% only when boiler is in the „OFF“ or „END“ phase.

6.1.5. Boiler shut-down (automatic)

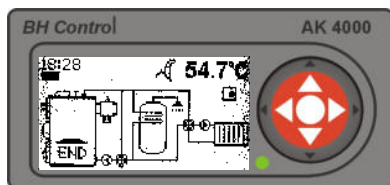

When exhaust gas temperature drops under the set-up temperature (📉 end), the boiler is automatically switched-off. Sign „END“ will be indicated on the display. By pressing the „ENTER“ button twice, the boiler will start operating again.

7. VIGAS Lambda Control BOILER CONFIGURED WITH THE DISCHARGE FAN:

The VIGAS boiler Lambda Control operates with information about oxygen overflow in exhaust gas received from the lambda sensor which controls the flap of primary and secondary air. This system allows burning of all types of wood more efficiently and at the same time reduces fuel consumption by 20-25 %.

7.1 VIGAS Lambda Control BOILER CONTROL:

7.1.1 Boiler activation

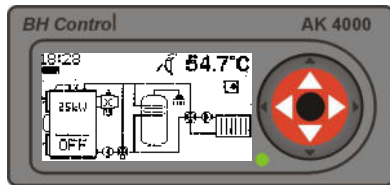

If the boiler is switched-off with symbol „OFF“ on the display, to re-start, press the middle button „ENTER“.

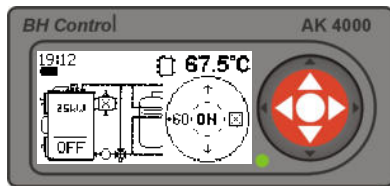

Choose one option	
+60	Start-up discharge fan for 60 secs (recommended in the heating phase)
ON	Switch on
<input checked="" type="checkbox"/>	Cancel display driver
▼ ▲	Change indicated figure

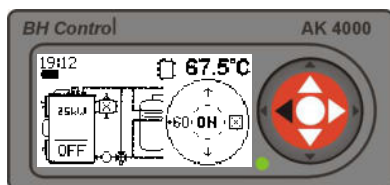

Select „+60“ a new graphic drive will be displayed. Running time of discharge fan is located in the left upper hand corner of the display.	
+60	You can add an extra 60 secs to a maximum of 300 secs
ON	Switch on
0	Discharge fan turns-off
▲ ▼	Change indicated figure

7.1.2 Boiler activated – heating phase „ON“

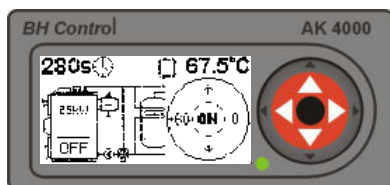

By pressing „ON“ button the servo-controlled flap will move to an open position (servo 100 %). Consequently, the following sequence 100% down to 45% will move the flap to retain the lambda sensor value of λ 1,35. When displaying servo at 45%, secondary air is closed. When displaying 0% primary air is also closed. The flap will move to position 0% only when boiler is in the „OFF“ or „END“ phase.

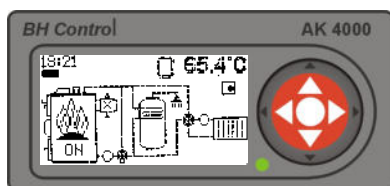

In the heating phase boiler gas exhaust temperature is lower then set-up minimum exhaust gas temperature. Minimum and maximum temperatures can be modified in boiler set-up parameters. Minimum standard exhaust gas temperature set-up is up to 50°C and maximum set-up temperature is 220°C. The pump operates in a **continuous** wave during open burn, depending on the boiler water temperature.

7.1.3 Boiler activated – burning phase „79°C“

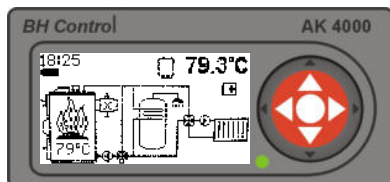

The burning phase is active, when the exhaust gas temperature is (end) +10 °C or after reaching desired temp. Burning phase is controlled by PID regulator on the basis of chimney and boiler temp. If the temperature rises 1°C above desired temp., the output will be 0%. If it decreases >2°C below desired temp., the output will start again.

7.1.4 Add fuel, boiler shut-down (manual control)

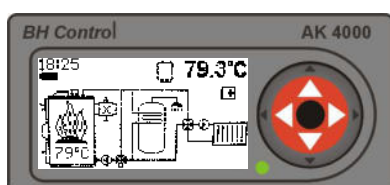

The graphic control is used for this operation. To activate the display driver press the middle button ENTER. Graphic control gives options: switch-off boiler, add fuel or cancel display driver.

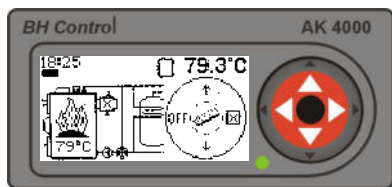

Choose one option	
OFF	Switch off
	Add fuel
<input checked="" type="checkbox"/>	Cancel display driver
	Change indicated figure

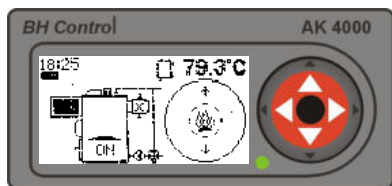
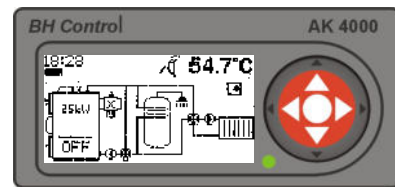

By pressing the boiler fan will be switched-off and the discharge fan will be switched-on for 300 secs. The time is indicated in the upper left hand corner of the display. By pressing button „+60“ it is possible to extend the discharge fan running time. Using the lever, open chimney flap and consequently open the upper door. You can add fuel if necessary.

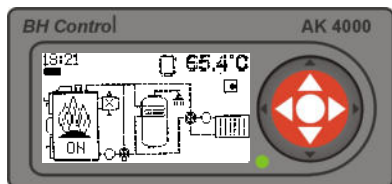

When fuel reloading is complete, close the upper door and chimney flap. By pressing „0“ the discharge fan will be switched off. By pressing fuel reloading is ended and the discharge fan automatically switches off and the boiler fan is switched on. During fuel reloading the servo-controlled flap remains in the same position as it was before adding fuel. When fuel refilling is finished, the flap moves to position (servo 100%). Consequently, the following sequence 100% down to 45% will move the flap to retain the lambda sensor value of λ 1,35. When displaying servo at 45%, secondary air is closed. When displaying 0% primary air is also closed. The flap will move to position 0% only when boiler is in the „OFF“ or „END“ phase.

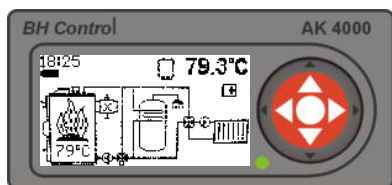

7.1.5. Boiler shut-down (automatic)

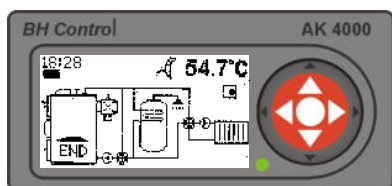

When exhaust gas temperature drops under the set-up temperature (end) the boiler is switched off automatically. Symbol „END“ will appear on the display. The servo-controlled flap will move to position (servo 0%). In this position primary and secondary air are closed. By pressing the „ENTER“ button twice, the boiler will start operating again.

8. TEMPERATURE SET-UP

By pressing „ENTER“ button for 2 seconds temperature set-up can be changed in any phase of the boiler. In the basic configuration of the boiler (without EXPANDER AK4000), it is only possible to set-up boiler temperature. Temperature scale is between 70°C and 85°C.

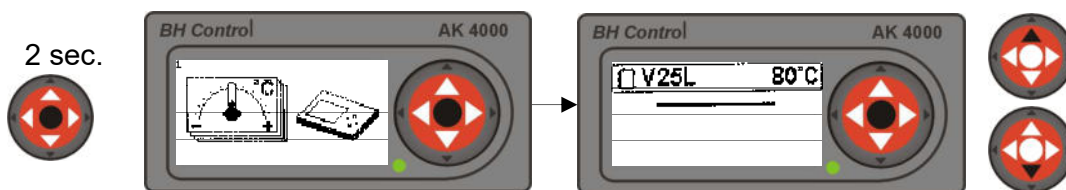

9. SET-UP PARAMETERS:

By pressing „ENTER“ button for 2 seconds set-up parameters can be changed in any boiler operating phase by pressing button. Set-up parameters depend on the type of boiler and its configuration.

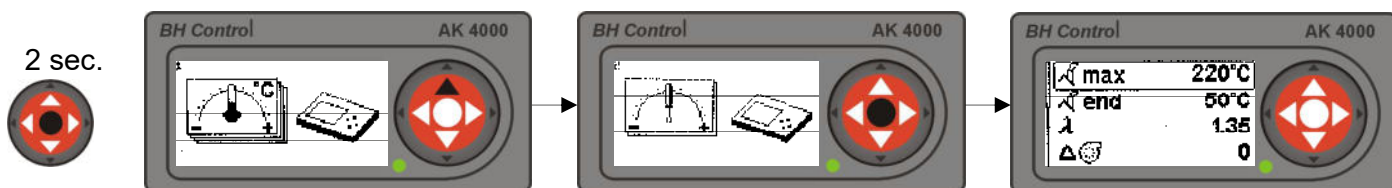

By pressing choose the required parameter and by pressing „ENTER“ symbol starts flashing. By pressing choose required parameter and confirm by pressing „ENTER“.

9.1 MAXIMUM EXHAUST GAS TEMPERATURE SET UP

			<p>Select maximum exhaust gas temperature, which will result in reducing fan speed. It is possible to set-up temperature between 130°C and 320°C. Temperature set-up depends on quality of fuel and chimney draught. Recommended value is 220°C.</p>
--	--	--	--

9.2 EXHAUST GAS TEMPERATURE SET-UP

			<p>You can set up exhaust gas temperature to automatically shut down boiler and pump. It is possible to set-up this temperature between 20°C and 130°C. If the temperature is too low, the fuel will burn completely. If the temperature is too high, there will be too much ash in ash in exchanger. By selecting the temperature, it is possible to control the size of fire base for the next heating phase.</p>
--	--	--	---

9.3 LAMBDA VALUE SET-UP

			<p>Lambda value specifies oxygen surplus in the exhaust gas. Recommended value is 1.35, which is about 6% of O₂. It is possible to set-up this value from 1,2 up to 1,5. By increasing the value of O₂ in the exhaust gas, the boiler and emissions will be less efficient.</p>
--	--	--	---

9.4 FAN OUTPUT SET-UP

			<p>By increasing or decreasing the value can change the nominal boiler output. It is possible to change the value from -3 to +3. One degree represents about 10% of boiler output. During warmer weather it is advised to decrease this value.</p>
--	--	--	--

9.5 FAN MINIMUM OUTPUT SET-UP

			<p>Increasing the value will change the minimum fan speed. Value can be selected between 0% and 70%. After reaching the selected set-up value the fan will switch off.</p>
--	--	--	--

9.6 MINIMUM TEMPERATURE IN THE ACCUMULATION TANK SET-UP

			<p>Setting the minimum temperature in the accumulation tank. Setting range 25-70°C. If the selected hydraulic diagram of the accu.tank (see 13.4) and the boiler exceeds the desired temperature by 1 ° C. of the boiler there is a transition to a state of depression The re-heating up of the boiler starts when the temperature in the accu.tank drops to a preset value eg. 30°C.</p>
--	--	--	---

9.7 DISCHARGE FAN SPEED SETTING

			<p>In case, the boiler is equipped with discharge fan (see chap.13.1.3), it can be used in permanent mode to increase chimney effectiveness. It is possible to control speed between 30% and 100% or complete shut down by „OFF“ symbol. If it is set as percentage, the fan works together with blower fan.</p>
--	--	--	--

9.8 DISPLAY INTENSITY SET-UP

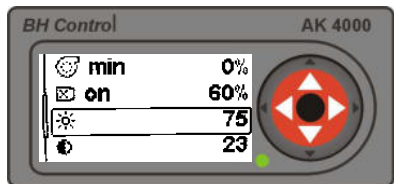

* Choose display intensity value. Select value between 0 and 100.

9.9 DISPLAY CONTRAST SET-UP

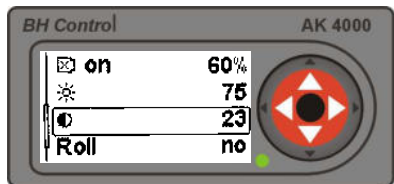

☾ Choose display contrast value. Select value between 18 and 34.

9.10 SCROLLING MENU SET-UP

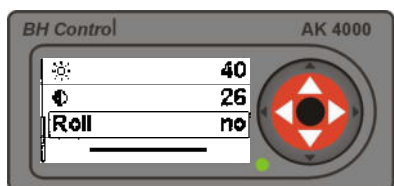

Roll By choosing „yes“ option on the display (pic.7) will show actual boiler values - for example: fan speed, boiler temperature, exhaust gas temperature, etc. By choosing „no“ option, selection can be made using buttons ▲▼.

10. TIME SET-UP

Set-up time and date when the boiler is first plugged in. Time is indicated in the upper left hand corner of the display. To retrieve parametre settings press and hold „ENTER“ at any boiler phase and then press ▲ button twice.

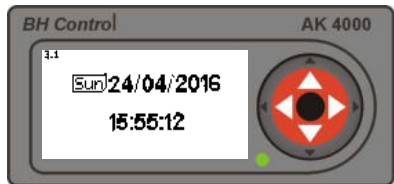
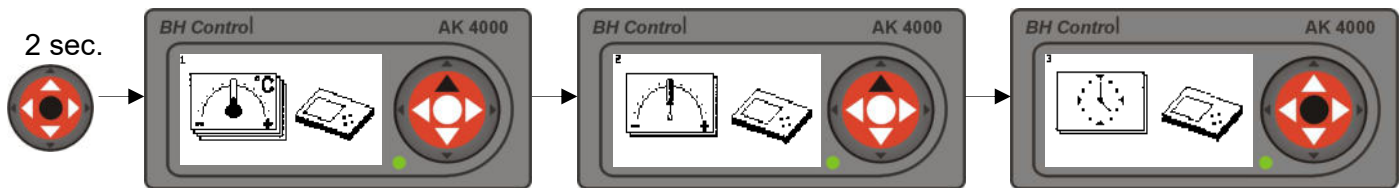

By pressing „ENTER“ button, values start flashing. Pressing ▲▼ choose correct time and date. Mon – Monday, Tue – Tuesday, Wed – Wednesday, Thu – Thursday, Fri – Friday, Sat – Saturday, Sun – Sunday.

Warning : During an electricity power-cut clock will stop.

11. HARDWARE AND SOFTWARE INFORMATION

To retrieve information setting, press and hold „ENTER“ button at any boiler phase and press button ▼. Confirm by pressing „ENTER“. Use buttons ▲▼ to choose module and confirm by pressing „ENTER“. Information about the module will be indicated on the display. AK4000D – Display, AK4000S – Power board unit, AK4000L – Lambda board module.

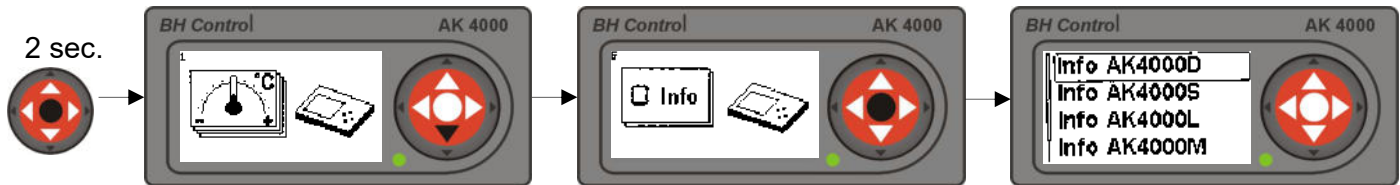

12. ERROR NOTIFICATIONS

To recall error notification press and hold „ENTER“ button at any boiler phase and press ▼ button twice. By pressing „ENTER“, error with description will be indicated on the display.

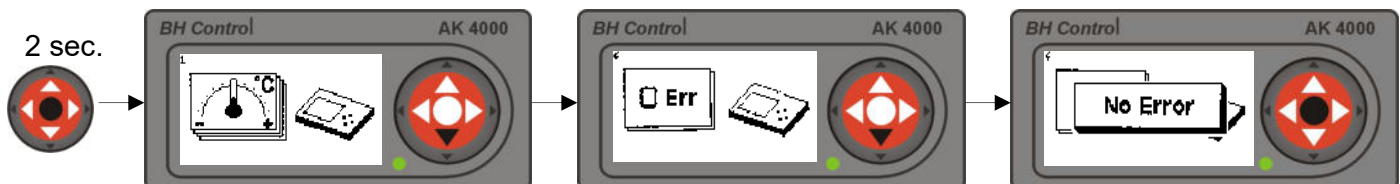

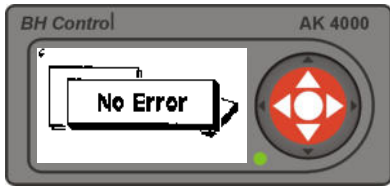

No errors = Green LED indicator
 Errors = Red LED indicator
 Error notifications and solutions are described in chapter 18.
 PROBLEMS, CAUSES AND SOLUTIONS“

12.1 STB failure

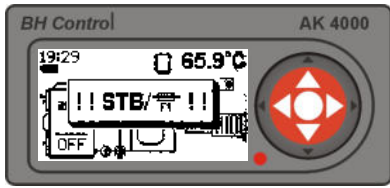

„STB“ failure is caused by the boiler over-heating. When this happens, the thermal fuse is activated (see pic.) and the fan is disconnected from the power supply. The boiler is only re- activated if „STB“ is reset manually only when the boiler temperature is below 60°C. To switch on the boiler press „ENTER“ button.



13. SERVICE SETTINGS PIN 0000 PROTECTED

Service settings are passworded. Only a trained service engineer can alter these settings. **PIN 0000** can only be used to alter settings in unavoidable instances. In service settings, boiler type can be selected together with accessories and hydraulic connection schematic, etc. To select service settings using password „PIN 0000“ press and hold „ENTER“ button at anytime, press ▲ button and then press and hold button ◀ for 4 seconds. „PIN 0000“ will appear. Press „ENTER“ button 4 times. Service setting symbol will appear on the display. Press „ENTER“ and by choosing buttons ▲ ▼ select service operation.

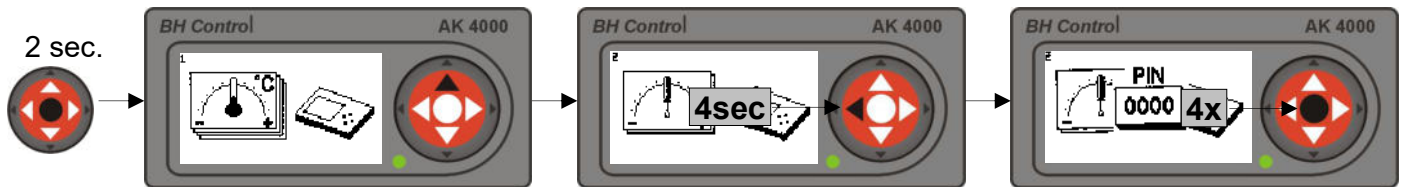

13.1 SERVICE SETTINGS

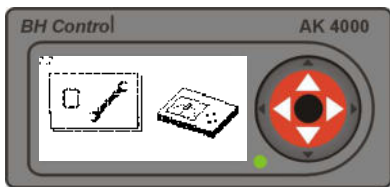

ATTENTION!

The control display unit of the boiler AK4000 is used to operate all types of VIGAS boilers. It is important that the symbol displayed is the same as the boiler type. When the boiler is in „OFF“ phase the visual display shows the type of boiler which is compliant with its nominal output. **For correct boiler operation the type of the boiler must always be the same as the type indicated on the production label. Always check, in case the AK4000 display is replaced!!!**

13.1.1 Boiler type setting

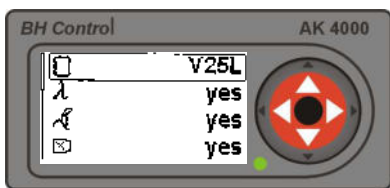

Choose boiler type. Type of boiler must be identical with boiler type indicated on the production label. Marked: V25 - boiler output TVZ – hotair boiler, UD – wood-coal, DP – wood-pellets, L – Lambda control.

13.1.2 Lambda sensor setting

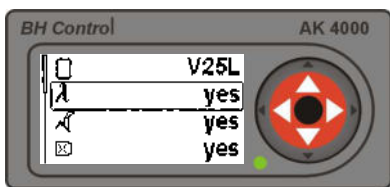

It is possible to de-activate the lambda sensor from operation if an error occurs. If this happens, it is possible to run the boiler in standard version until the lambda sensor is replaced.
yes = boiler with lambda sensor, **no** = boiler without lambda sensor

13.1.3 Exhaust gas thermometer settings

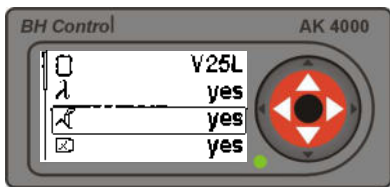

In case of exhaust gas thermometer error, it is possible to disconnect the thermometer. The boiler will operate without the thermometer until it is replaced. Exhaust gas thermometer will not be used, when the boiler is de-activated, use boiler thermometer symbol: **yes** = boiler with thermometer, **no** = boiler without thermometer.

13.1.4 Discharge fan settings

			<p>The discharge fan is an accessory that can be used with the boiler. After connection to the boiler and in AK4000 control, it is necessary to choose option „yes“.</p> <p>yes = boiler with discharge fan, no = boiler without discharge fan.</p>
--	--	--	---

13.1.5 Boiler thermometer setting

			<p>There is a possibility to set two types of boiler thermometers</p> <ol style="list-style-type: none"> 1.Standard: Type KTY 2.Alternate: Type PT 1000
--	--	--	---

13.1.6 Maximum chimney temperature settings

			<p>Maximum chimney temperature setting can be selected between 75°C and 90°C. Highest value is used for boiler settings with accumulator tank.</p>
--	--	--	--

13.1.7 Minimal temperature setting for boilers with accumulation tank

			<p>Setting the minimum temperature in the accumulation tank. Setting range 25-70°C. If the selected hydraulic diagram of the accu.tank (see 13.4) and the boiler exceeds the desired temperature by 1 ° C. of the boiler there is a transition to a state of depression The re-heating up of the boiler starts when the temperature in the accu.tank drops to a preset value eg. 40°C.</p>
--	--	--	---

13.1.8 Frequency power supply set-up

			<p>Frequency power supply setting is 50 Hz for EU residents and 60 Hz for USA and Canadian residents. If you are not aware of power supply frequency, choose AUTO. Incorrect frequency can cause clock error.</p>
--	--	--	---

13.1.9 Temperature unit setting

			<p>For temperature unit setting °C-Centigrade or F-Fahrenheit can be selected.</p>
--	--	--	--







13.1.10 Summer time setting

			<p>Allows set-up to automatically change the clock to summer-time.</p>
--	--	--	--

13.2 MODULE AK 4000M SETTINGS

When necessary, it is possible to connect AK4000 control to module AK4000M (pic.8). This module allows the provision of upgrades and back-up data maintenance of the boiler control unit. The module is equipped with data to make it possible to connect to BH BUS power board.



 → config	To load a new configuration (connection schematic). Mainly used for systems controlled by EXPANDER AK4000E, where it is possible to load personal connection schematics.
 ← config	Actual configuration back-up. It is used for boiler monitoring. It is advised to perform before monitoring.
 → firmware	To load firmware (boiler operating software).
 Erase	To delete information from module AK4000M.
 → mon	Boiler monitoring - to file basic information of the boiler into memory module.
 → AK4000S	To load firmware into the power board AK4000S.
 → AK4000L	To load firmware into the lambda power board AK4000.

13.3 SERVICE CONTROL FUNCTIONS

In service settings the functions of each boiler's components can be checked according to the symbols indicated on the display. By selecting component and pressing „ENTER“ button the function will be activated. Displayed components depend on the boiler's configuration.



13.4 HYDRAULIC SCHEME BOILER SETTING

By changing hydraulic scheme connection will also change the control of the pump output and boiler configuration. Therefore, it is very important that software settings for the hydraulic schematic is identical with existing boiler installation in the central heating system. In the basic memory of the control unit are 4 basic schemes and schemes intended for operating with the Expander AK4000E. On demand, it is possible to add Expander schemes via AK4000M module (pic.8). Updated schemes for Expander AK4000E can be found on www.vigas.eu

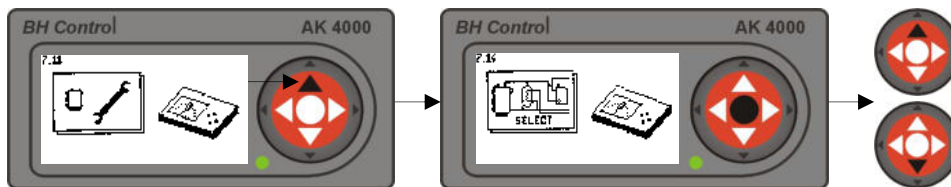

Using ▲▼ buttons, choose required scheme and press „ENTER“.

13.4.1 BASIC CONNECTION SCHEMES

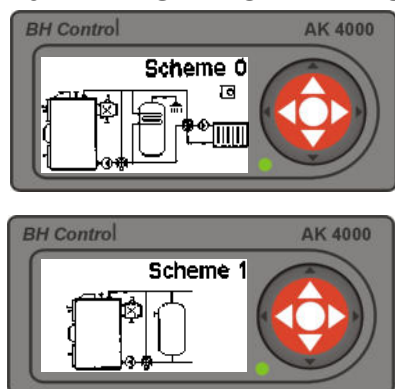

Schema 0 for (basic schema/BS-1) to protect from low-temperature corrosion, a three-way thermostatic valve ESBE is used (60°C). Water regulation for central heating is secured by 4-way mixing valve with manual control. For boiler heating, a combined tank is used. Both pumps must be connected to power board AK4000. Contact T3 of power board AK4000S is used for connection of room thermostat (see 20/B2 and 16.4.)

Schema 1 for (BS-3) shall be used with accumulator tank. To protect from low-temperature corrosion, a three-way thermostatic valve ESBE is used (60°C). Pump shall be connected to power board AK4000. Contact T3 of power board AK4000S is used to connect KTY sensor, to monitor tank temperature.

Attention: It is not possible to connect room thermostat with Schema 1. It is recommended to control the room thermostat by pump.

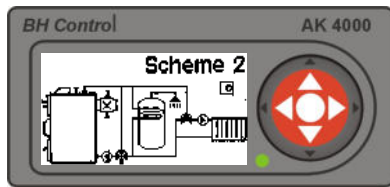

Schema 2 for (BS-2) Scheme is the same as scheme 0. To control water temperature for central heating, the 3-way mixing valve is used, which is operated manually.

Attention: Combines water tank must be used together with 3-way mixing valve.

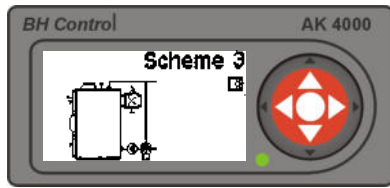

Schema 3 to protect from low-temperature corrosion, a three-way thermostatic valve ESBE is used (60°C). Pump must be connected to power board AK4000. Contact T3 of power board AK4000S is used for connection of room thermostat (see 20/B2 and 16.4.)

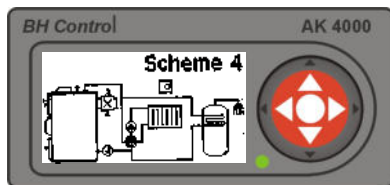

Schema 4 is designed for manual control with 4-way valve. For boiler heating, a combined tank is used. Both pumps must be connected to power board AK4000. Contact T3 of power board AK4000S is used for connection of room thermostat (see 20/B2 and 16.4.)

Recommendation: Connection without 3-way thermostatic valve does not secure sufficiently water temperature to 60°C. In order to expand the lifespan of boilers, it is recommended to use Scheme 0.

13.4.2 CONNECTION SCHEMES WITH EXPANDER AK4000E

Expander AK4000E complements the AK4000 boiler control unit. It enables the possibility to control the central heating system unit circuits, including regulating the supply water temperature, using different heating sources. Use of indoor thermostat and equithermic control (based on external temperature) or in combination, enables control of the central heating. Expander AK4000E is supplied in sets. According to the particular schematic connection, it is supplied as: basic set (order no. 5001), double set (order no. 5002) and triple set (order no. 5003). After verifying the connection schemes of the Expander, service settings will be supplied with unit settings for the central heating system and hot water supply. (Detailed description given in EXPANDER AK4000E service guide).

Technical requirements for additional accessories:

(To specify type, pump diameter and servo-unit consult with boiler specialist!)

1. Pump 230V/50 Hz.
2. Servo-unit 230V/50 Hz opening period 60–240 secs
3. Pump to be installed circa 0,5 m after 4-way valve.
4. Maximum electrical current for one EXPANDER is 3Amps.
5. Additional thermometer to be installed circa 0,5 m after pump.
6. External thermometer to be installed on the nothern side of building
7. Indoor thermostat - free of voltage.

Expander Basic set (order no. 5001)

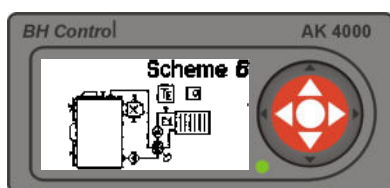

Schema 5 used with one heating circuit for floor or radiator. Central heating temperature can be controlled according to external temperature, room thermostat or by combination of both. The boiler pump and central heating pump are controlled separately. Boiler protection against low-temperature corrosion provides 4-way valve with servounit.

Use: Expander basic set (code 5001).

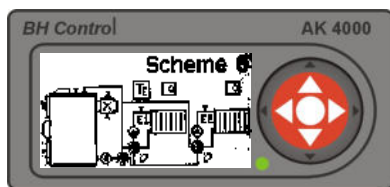

Schema 6 with two separate heating circuits controlled by servounit. Option to choose floor or radiator heating or combination. Central heating temperature can be controlled according to external temperature, room thermostat or with combination of both. The boiler pump and central heating pump work separately. Boiler protection against low-temperature corrosion provides 3-way thermostatic valve (60°C).

Use: Expander double set (code 5002).

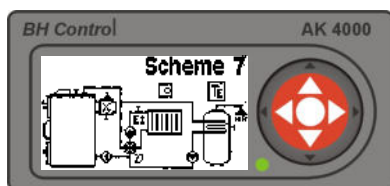

Schema 7 for (Basic scheme expander (BSE 1)) used with one heating circuit controlled by servounit for floor or radiator heating. Heating of domestic water supply is controlled by pump. Temperature of central heating is controlled by external temperature, room thermostat or by combination of both. Boiler protection against low-temperature corrosion provides 4-way mixing valve.

Use: Expander basic set (code 5001)

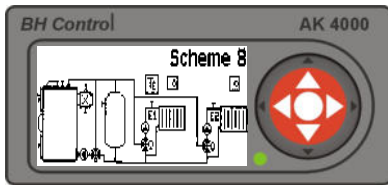

Schema 8 with two separate heating circuits and accumulator tank. Option to choose floor or radiator heating or combination of both. Temperature of central heating can be regulated according to external temperature, room thermostat or by combination of both. Boiler protection against low-temperature corrosion provides 3-way thermostatic valve (60 °C).

Use: Expander double set (code 5002) + 1 x sensor KTY (code 3032).

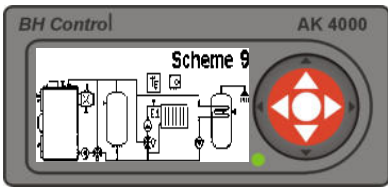

Schema 9 for (BSE-2) with one heating circuit of central heating system using servounit with accumulator tank. Heating of warm domestic water is controlled by pump. Water temperature can be regulated on the basis of external temperature, room thermostat or the combination of the two. 3-way thermostatic valve (60°C) secures the protection of boiler against low-temperature corrosion.

Use: Expander basic set (code 5001) + 1x tank sensor KTY (code 3032)

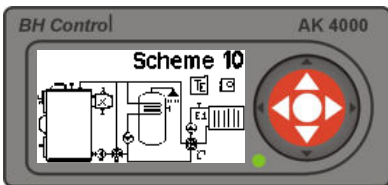

Schema 10 is used with one heating circuit controlled by servounit for floor or radiator heating. Heating of domestic water supply is controlled by pump. Temperature of central heating is controlled by external temperature, room thermostat or by combination of both. Boiler protection against low-temperature corrosion provides 4-way mixing valve.

Use: Expander basic set (code 5001)

13.5 DISPLAY LINE

Riadkové zobrazenie umožňuje prehľadne zobraziť jednotlivé údaje riadiaceho systému AK4000. Tlačidlami ▲▼ zvolíte požadovaný údaj a potvrdíte tlačidlom „ENTER“. Označené údaje budú zobrazené v riadkových informáciách (kap.3.5).

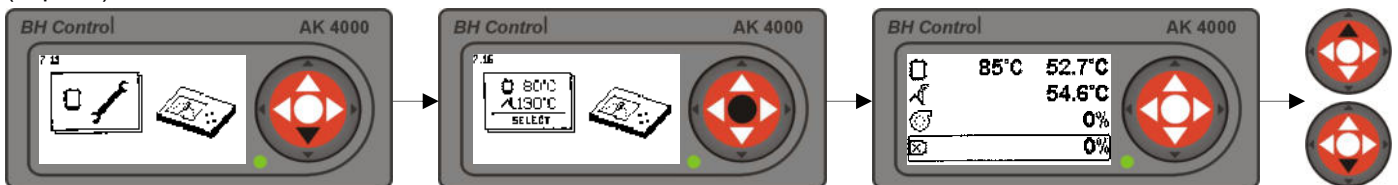

13.6 AK4000 CONTROL SYSTEM ELECTRICAL CONNECTION - INPUTS AND OUTPUTS

The AK4000 control system enables the display of both input and output according to actual configuration of the boiler for particular contacts.

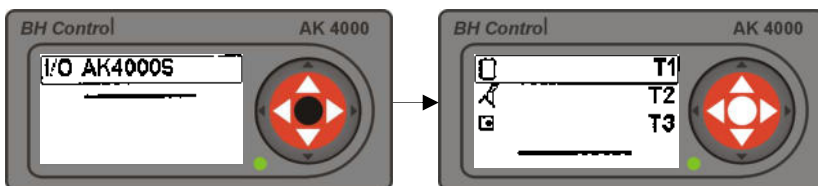
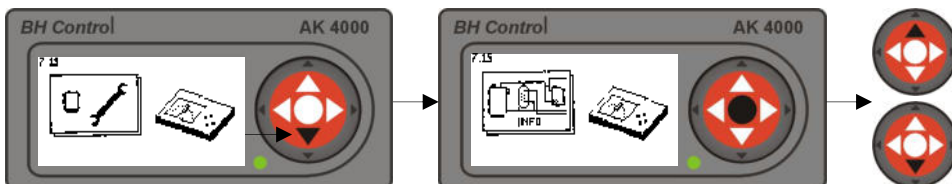

	T1	Boiler thermometer T1
	T2	Exhaust gas thermometer T2
	T3	Indoor thermostat T3
	T3	Or accu. Thermometer T3

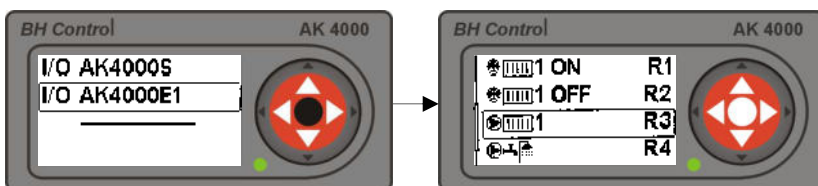

	1 T2	Thermometer UK1 to T2
	1 R3	Pump voltage UK1 to R3
	1 ON R1	Phase servo-unit „OPEN“ to R1
	1 OFF R2	Phase servo-unit „CLOSE“ on R2

14. OPERATING INSTRUCTIONS

14.1 Before operation:

- Read and become fully familiar with the operating instructions, manual and the AK4000 electronic control.
- Check water pressure in central heating system (max. 3 bar).
- Connect electrical components (example: pump, discharge fan, indoor thermostat, etc..)
- Check fireclay brick supports inside the combustion chamber (pic.3)
- Check metal panel covers.
- Check power supply connection (230V/50 Hz) ,
- Prepare a sufficient amount of fuel for the burning and heating phase.

14.2 Boiler in operation

1. Connect boiler to power supply network (230V/50Hz) using the power lead.
2. Wait until the visual display basic image is activated:
 - a) Boiler without lambda sensor - immediately
 - b) Boiler with lambda sensor – around 30 secs (automatic servo-unit initialization).
3. Refer to points 4–7 and choose the configuration that matches the boiler installation with accessories to help handling AK4000 control.
4. Set the boiler AK4000 control to deactivated phase **"OFF"**.
5. Fuel heating:
 - a) using lever, open chimney (pic.3/3),
 - b) open upper door (pic.3/2) and place paper on the fireproof nozzle (pic.3/9), so that a small piece extends to lower burning chamber (pic.3/25), cover with woodchips, then place wood cuts on top and fill-up with solid wood logs,
 - c) close upper door and open the lower door slightly (pic.3/13) to achieve fuel heat in the chamber (pic.3/4), if the boiler is equipped with discharge fan use for quick start.
 - d) when fire base is created (takes approx. 10-15 minutes), close the lower door and chimney flap using the lever.
6. Switch the boiler „**ON**“. Boiler will start combustion and will control its output automatically up to the required temperature.
7. To refill with fuel follow steps in chap. 4–7.
8. To shut-down the boiler follow instructions in chap. 4–7.

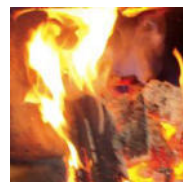

Burning base





Lower door open

14.3 REGULATING OPERATION AND OUTPUT

Fuel inside the boiler moves spontaneously towards the fireproof nozzle. Ash falls through the nozzle and is deposited in the combustion chamber. Boiler output is regulated automatically according to the set-up temperature of outlet water. If there is a mains power cut over a long period of time or if the automatic control fails, it is possible to heat as follows (only applicable for central heating systems with gravitation flow): open chimney flap and open bottom door a little. If this way of heating is used, it is necessary to check outlet temperature more frequently and to add less fuel. The boiler may easily become overheated, if the chamber is full.

14.4 REFILLING THE CHAMBER WITH FUEL

- using lever open chimney flap (pic.3/3),
- press „“ button on the display (chap. 4–7),
- open upper door with caution, to allow smoke to disappear,
- through upper door (pic.3/2) refill with fuel as necessary
- close upper door (pic.3/2) and chimney flap (pic.3/3),
- by pressing „“ button finish fuel refill



Wood characteristic table

Wood	Fuel efficiency [MJ/kg] 20% humidity	Fuel efficiency [MJ/kg] 25% humidity	Hardness *	weight [kg/m ³] 25% humidity
Poplar	12,9	12,3	1	530
Fir	15,9	14,0	1	575
Spurce	15,3	13,1	1	575
Willow	16,9	12,8	1	665
Pine	18,4	13,6	1	680
Alder	16,7	12,9	2	640
Birch	15	13,5	2	780
Maple	15	13,6	4	660
Beech	15,5	12,5	4	865
Ashen	15,7	12,7	4	865
Locust	16,3	12,7	4	930
Oak	15,9	13,2	4,5	840

[kg/m³] = [kg/fm], fm – fullmeter, * (1 very soft...5 very hard)

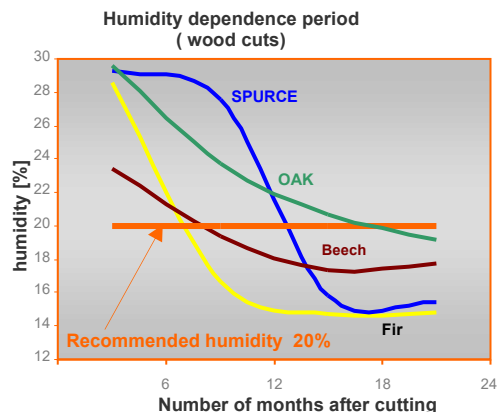

ATTENTION!!!

- Use only recommended fuel.
- **It is advise not to overload the boiler with fuel when in temporary period, boiler tar can be decreased.**
- When adding fuel, do not load between the flange and the chimney flap, which can cause inaccurate flap closure.
- It is important to lay fuel properly, so it will not stop the upper door from closing. Forcing the door closed may damage the door's concrete innerwall.
- It is recommended that only people over 18 years of age should operate the boiler.

14.5 BOILER SERVICING & CLEANING

During optimal wood burning and keeping minimum temperature of the reverse water at 60°C will ensure that the gasifying chamber and exchanger will only slightly soot. Using damp wood may cause steam to condense on the walls of the combustion chamber, which creates tar on the surface.

▪ **Gasification chamber cleaning**

It is necessary to remove tar from the gasification chamber once a week. It is recommended to burn it off with the upper door and chimney flap open. If there is extra ash which did not fall through the nozzle (9)pic.3 into the fireclay combustion chamber, this should be removed from time to time. Fuel bunker will be increased to original size and primary air flow through nozzle will be increased.



▪ **Combustion chamber cleaning**

It is recommended to sweep out ash and dust that has fallen and settled in the combustion chamber once every 3-5 days.



▪ **Exchanger cleaning**

It is necessary to clean exchanger pipes once a month using the fire rake (round plate).

Recommendation: If the exchanger is not cleaned regularly it will become clogged with tar. Do not use a solvent. The boiler must be cleaned whilst it is hot! Heat boiler to approx 80°C (without fan) through open upper door and chimney flap. Then close the flap and door. Using gloves, carefully open exchanger cover. Clean clogged pipes with relevant accessories. After cleaning, close exchanger cover and let the boiler burn / gasify for approx. 5 hours at maximum performance, in order to get rid of any remaining tar.



Warning: During cleaning the boiler room must be well ventilated!

Step 1.



Step 2.



Step 3.

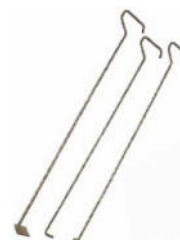

▪ VIGAS UD29 boiler cleaning

If using brown coal as fuel, cleaning will be the same as a wood burning boiler. Clean fuel bunker with cleaning flap (12) pic.3 and ash-drawer as follows:

1. Open bottom door (15) pic.3, insert drawer and close the door.
2. Open cleaning flap and upper door (2) pic.5.
3. Use relevant accessory to pile up ash from fuel bunker area into drawer
4. Wait a moment, open bottom door, take out drawer and close the door.

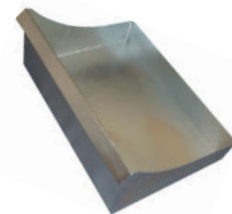

ATTENTION:

Do not leave ash-drawer inside the boiler VIGAS 29 UD during use.

15. BOILER MAINTENANCE AND REPAIRS

The contractor provides regular checks and boiler maintenance. During operation it is important to check water pressure, door seals, chimney flap tightness, exchanger cover and seal, flue cleanliness and fan performance.

WARNING :

Before boiler is shut-down for the summer season, clean combustion chamber thoroughly, do not leave any condensed moisture inside and open bottom door and chimney flap.

15.1 DOOR SEAL

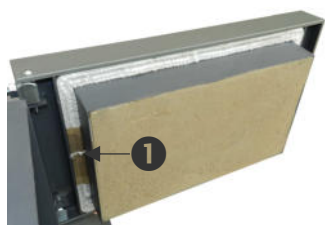

The boiler door is stabilized in 3 ways – two rotary pins and a door catch. If the door does not fit tightly, it is also possible to fix it from the hinge side. Slightly turn hinge to release and turn by hinge screw and then move door in desired direction. To change gasket 1 points out the place, where gasket is joined.

15.2 CHIMNEY FLAP TIGHTNESS

When cleaning exchanger pipes (pic.3/24) make sure that the flap area is clean, as well as the flap itself. (pic.3/16). Leakage can decrease boiler performance.

15.3 Heatproof nozzle



The heatproof nozzle is a block made of heat-proof concrete and its use is to mix gases with secondary air to ensure efficient burning. The nozzle is located on the water cooling rack. The nozzle is surrounded with heat-proof concrete at the same height as the nozzle. The life of the nozzle is dependent on mechanical damage as a result of fuel loading or stoking the fire. Therefore, the nozzle is considered as a spare part. Cracks noticed on the nozzle are not a reason to change the nozzle. It is only necessary to change the nozzle if it is dropped or is broken. Remove the pieces of the broken nozzle and replace with a new nozzle ensuring that it is inserted and fits into the opening.

15.4 FLAP & SERVO-UNIT POSITION SET-UP FOR VIGAS BOILER Lambda Control

It is very important that the servo-unit and flap are in the correct position to control primary and secondary air in the burning process to ensure minimum emissions. To position the servo-unit and flap follow these steps:

- Step 1:** unplug line connector from the power supply 230V/50Hz,
- Step 2:** loosen screw „1“ with spanner,
- Step 3:** using a spanner turn the axle (which must turn easily!) anti-clockwise „2“ to maximum position. Visually check the flap motion through the window „3“.
- Step 4:** tighten screw „1“
- Step 5:** plug in power lead to power supply 230V/50Hz.

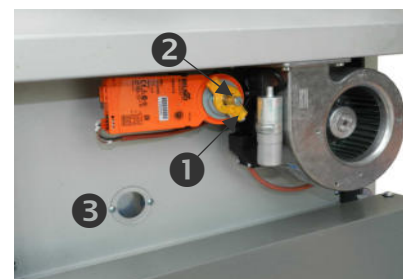

When the power lead is plugged in, the power supply to the servo-unit will start automatic initialization, which is also shown on the display. During this initialization servo-unit moves.

15.5 SECONDARY AIR FLAPS POSITION SET-UP

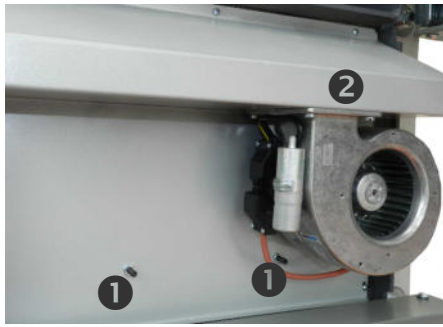

The position of the secondary air flaps can considerably affect burning quality. VIGAS Lambda Control boilers control the amount of secondary air automatically. This option provides optimum conditions for burning of all wood types. In VIGAS boilers without lambda sensor the mixture of primary and secondary air can be adjusted by screws „1“. Optimum adjustment of secondary air screws „1“ is 2,5 turns from factory set. To change or control position follow these steps:

- Step 1:** loosen the safety bolt nut on screw „1“,
- Step 2:** drive screw „1“ in towards boiler all the way
- Step 3:** then, adjust by 2,5 turn (optimum),
- Step 4:** tighten safety bolt nut.

TURN	FUEL
0	Not recommended
1	Wet wood
1,5	Wet softwood
2	Dry softwood
2,5	Dry hardwood
2,5 +	Very dry hardwood, small chips

Boilers without lambda sensor are equipped with a safety flap (above the fan) „2“ which stops air going through the fanin to the boiler when the fan is stoppped (only chimney draught). In case the boiler does not have sufficient output, check the function of this.

15.6 LAMBDA SENSOR AND EXHAUST GAS THERMOMETER



The Lambda sensor and exhaust gas thermometer must be clean to function properly. When cleaning exchanger always gently wipe away dust from the lambda sensor „1“ and exhaust gas thermometer „2“.

Important: Thermometer must be in accurate position. Its metal insert must be at the same level as mettalic sleeve. (By changing the position of the thermometer will alter the temperature considerably.) Connect the lambda sensor and exhaust gas thermometer to „3“ and „4“ boxes.

15.7 SECONDARY AIR SYSTEM CLEANING

Cleaning the boiler’s pipe airway system is necessary to achieve optimum burning. If sawdust is used as a fuel often, the airway must be cleaned at least once in the season. The system is built with primary and secondary air trunks. The boiler construction disassembly of parts to enable areas to be cleaned. When the fan cover is removed (8) pic.3 this allows ccess to the fan. To clean the pipe airway system take the following steps:

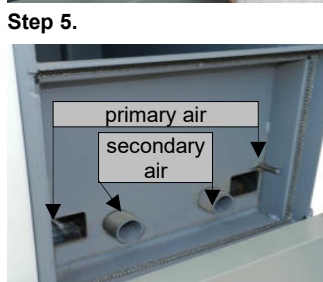

Secondary airway cleaning

Attention!!! During cleaning disconnect the boiler from the power supply!

- Step 1:** Unplug fan and flap servo-unit connectors
- Step 2:** Under the fan plate removal (see chap 15.4 for assembly)
- Step 3:** Vacuum out the secondary air pipes and check if it is clean.

Step 6./a

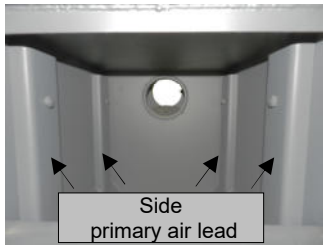

Primary airway cleaning

Check primary airway pipes and only clean if necessary. Congestion can occur when using wet wood or boiler runs for a long time in low performance. Type of primary airway design is different for each boiler model.

Step 4: Dismantle primary air separation panel.

Step 5: Use vacuum and scraper to clean primary leads and check if clean.

Step 6: It is possible to dismantle the vertical primary air lead but only if it is absolutely necessary. With boilers VIGAS 16, VIGAS 25 a VIGAS 40 side primary air tube, also (step 6/a, step 6/b).

Step 6./b



Note: It is necessary to use silicone heatproof seal, when this action is repeated.

16. ACCESSORIES AND ASSEMBLY.

16.1 SAFETY DRAIN VALVE

Cooling safety exchanger use:



A cooling safety exchanger with drain valve TS 131 provides boiler protection against overheating during a power cut. By forced circulation the pump and water flow in the central heating will shut down. If there is not an option to have an automatic gravity convection or minimum heat consumption of 5 kW, the boiler may overheat. The drain valve TS 131 and cooling exchanger will stop the boiler from overheating.

Assembly of drain valve TS 131:

Screw the drain valve TS 131 into the boiler socket „1“ so it is water tight. The safety exchanger must be water tight. The second connection „3“ pic., must be connected to drain via a tundish. Insert the thermal sensor into ½“ socket, pic. „2“.

Warning:

- The assembly of the valve and thermal sensor is necessary before the central heating system is filled with water.
- The pressure of cooling water can not be lower than the pressure of the mains water.
- It is advised not to loosen the ¾“ socket „2“ pic. This can cause water leakage. There is an aluminium ring „4“ under the insert „3“ to seal the copper pipe „5“. If there is a water leak, tighten ¾“ insert „2“.

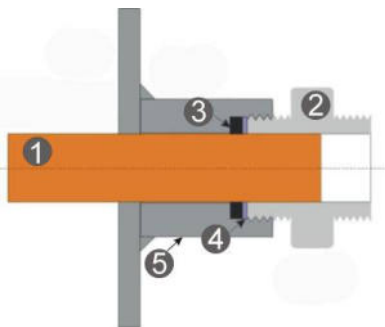

Operation rule:

The drain valve is regulated by hot water. If the water temperature is 95°C the valve opens. Water running from main source will absorb the temperature from the boiler and prevent it from possible damage and overheating. This boiler protection system complies with standards STN EN 303-5:2012.

16.2 DISCHARGE FAN

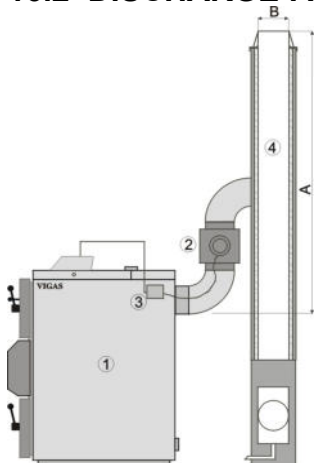

The discharge fan „2“ is designed to eliminate exhaust gas in the boiler area during fuel refilling. In case the boiler's chimney does not comply with minimum parameters „A“ and „B“, it is recommended to install a discharge fan. This should be installed between the chimney flue and the chimney body. The condenser „3“ should be attached on the side of the boiler. It is connected to the power board unit. It is possible to order the AK 4000S in two different sizes. V25 (order no. 0507) – for VIGAS 16, 18DPA, 25, 29 UD. V80 (order no. 0508) – for VIGAS 40, 60, 80, 100.

Boiler type	Min A	Min B
VIGAS 16, VIGAS 18 DPA, VIGAS 25	8 m	160 mm
VIGAS 40	8 m	200 mm
VIGAS 60, VIGAS 80, VIGAS 100	12 m	200 mm

Drawing of parameters V25 and V80 at - www.vigas.eu



16.3 CIRCULATION PUMP AND 3-WAY THERMOSTATIC VALVE ESBE



The electronic control allows the connection of the pump to the power board unit of the AK4000S without using an expander, even in basic version. The operation of the pump depends on the selected hydraulic scheme and boiler temperature. The pump operates in a pulsating cycle or persistent cycle.

Pulsating cycle allows the pump to go „ON“ or „OFF“ at specific times. The activity ratio depends on the boiler output temperature. The advantage of this cycle is to protect the boiler against low-temperature corrosion. Pump activity is indicated by blinking pump icon.

Persistent cycle is used only with a 3-way thermostatic valve or Ladomat installation. See chap. 13.4.1.

When the pump is in operation, the symbol will be flashing on the display.



16.4 INDOOR THERMOSTAT



By connecting the indoor thermostat to the boiler, maintenance will become easier. It is necessary to connect the indoor thermostat to the AK4000S power board. Connect to T3 input contact. The switching contact element is voltage free. If contact T3 is disconnected, the indoor thermostat „OFF“ sign will be displayed. The blower fan will shut-down. The boiler status is indicated by „“ symbol. When the indoor thermostat is „ON“ again, the boiler is activated.

16.5 COOPERATION OF VIGAS BOILER WITH ACCUMULATION TANK



As standard in the boilers VIGAS, one load is sufficient for 12 hours of operation which means that it uses less than 30% of rated output. In view of the life of the boiler it is preferred that the boiler operates at least at 50% of rated output. If the boiler VIGAS is used with ACCU tank, 100% of rated output is used to achieve the desired boiler temperature. If there is current requirement for heating, 100% output of the boiler is divided into charging ACCU tank and heating. In this case, the tank is recharged by the excess output of the boiler. In view of the fact that the boiler and ACCU tank is hydraulically connected to each other, the temperature of the ACCU tank and the boiler rises to the desired temperature of the boiler together. After exceeding this temperature by 10°C, boiler goes into the attenuation  (0% boiler output). In this mode, heating and charging ACCU tank is managed solely by means of pumps. The great advantage of this system control is that in the attenuation mode, it is possible at any time to add the fuel to the boiler, without overheating of the ACCU tank, which in practice increases the time between fuel loading. The automatic re-heating up takes place only after the exhaustion of ACCU tank at the selected temperature  **MinT**. ACCU tank minimal temperature volume can be adjusted from 20°C to 70°C. After burning out of fuel and decrease of chimney temperature to the boiler set  **end**, the boiler will shut down. In a combined automatic boiler VIGAS 18 DPA, after burning out of fuel "wood" boiler will automatically switch to fuel "pellets" and continue heating another few days.

NOTE: For all hydraulic circuits with ACCU tank, there must be a thermometer for ACCU tank (code 3032) connected to regulation AK4000 and its location to insert at the top of the accu. tank.

17. SERVICE DEPARTMENT

It is advised that repairs to the boiler must be carried out by authorised service engineers appointed by the manufacturer:



Pavel Vigaš - VIMAR, Príboj 796, Slovenská Ľupča, Slovakia.

tel. 00421 48 41 87 022.





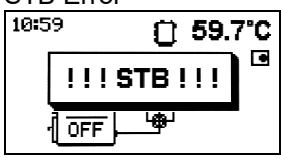
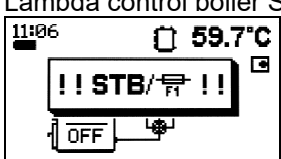
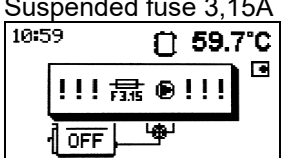

tel. 00421 48 41 87 159

email: vimar@vimar.sk, web: www.vigas.eu

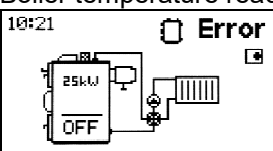
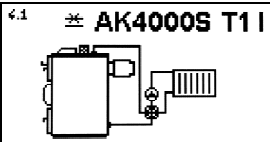
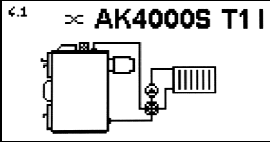
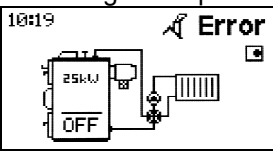
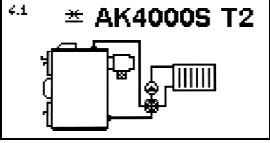
18. PROBLEMS, CAUSES AND SOLUTIONS

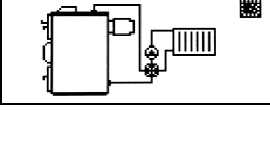
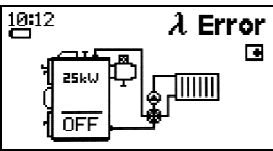
Problem	Cause / Solution
During heating season the boiler output is lower than previous heating period.	Fuel being used is wet. Clean pipe airway system. Clean fan air wings.
When chimney flap is closed, boiler does not perform then smoke appears.	Not enough primary air is getting through. Clean primary pipe airway system. Check if flap behind the blower is functioning.
Combustion chamber contains unburned wood.	Nozzle hole enlarged. Change nozzle. Set up secondary air to required position : 3 turns of flap back from closed position. Lower the temperature  end. See chap.9.2.
Smoke leaks through door seal after door is closed.	Door is not tight enough. Adjust the door. Check door is tight. Remove gasket and place other way round or replace gasket.
Difficulty in opening the chimney flap.	Chimney flap is glued by tar. Increase boiler operating temperature. Use dry fuel. Increase temperature  end. See chap. 9.2.
After upper door and chimney flap is opened, the boiler room beomes filled with smoke.	Low chimney draught. Chimney diametre must be bigger than diameter of boiler flue outlet. A discharge fan recommended. See chap.16.2.
Cracked fireproof/concrete/ filling	This is not a defect. Separates combustion chamber from gasification chamber.
Fan does not turn. It will only start working when pushed.	Fan condenser is defective . Change condenser.
After heating phase, the boiler shuts down.	Incorrect selection of „End“ temperature. See chap.9.2. for configuration.
Boiler is in shut-down mode, but the fan is still in operation.	Damaged wires leading to the fan. Zero leading wire is connected to ground wire
Pump is operating even though the symbol  does not show on the display.	Damaged pump wires. Zero leading wire of pump is connected to ground wire.
Warning indications and notifications	Cause/ Solution
T max	The display shows the statement "MAX" If the boiler temperature exceeds 93 ° C.

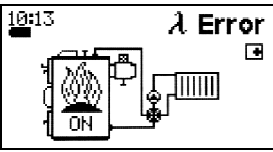
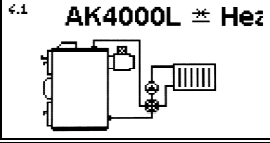
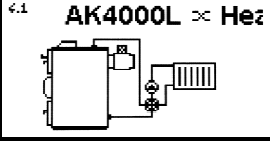
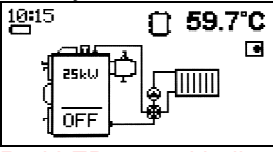
Error notification	Error identification (MENU 4)	Cause/ Solution
STB Error  Red control LED indicating		<input type="checkbox"/> Boiler overheated – when boiler cools down, reset STB fuse manually. See12.1.
Lambda control boiler STB error  Red control LED indicating		<input type="checkbox"/> Boiler overheated – when boiler cools down, reset STB fuse <input type="checkbox"/> Suspended fuse F1A, (F5 A) control system is conected from AK4000PS
Suspended fuse 3,15A  Red control LED indicating		<input type="checkbox"/> Suspended fuse 3,15A (F 5A) which joins boiler. <input type="checkbox"/> Check pump connection.

<p>Boiler temperature reading error</p>  <p>Red LED control indicates</p>	<p>Disconnected boiler thermometer AK4000D T1 KTY</p> 	<ul style="list-style-type: none"> <input type="checkbox"/> Disconnected thermometer - check thermometer <input type="checkbox"/> Damaged thermometer - replacement required
	<p>Boiler thermometer in short circuit AK4000D T1 KTY</p> 	<ul style="list-style-type: none"> <input type="checkbox"/> Damaged thermometer – replacement required <input type="checkbox"/> Short circuit in connection of thermometer - revise
<p>Exhaust gas temperature error</p>  <p>Red LED control indicates</p>	<p>Boiler exhaust gas thermometer disconnected AK4000D T2 KTY</p> 	<ul style="list-style-type: none"> <input type="checkbox"/> Disconnected chimney thermometer – check thermometer <input type="checkbox"/> Damaged chimney thermometer – replacement required.
	<p>Exhaust gas thermometer short circuit AK4000D T2 KTY</p> 	<ul style="list-style-type: none"> <input type="checkbox"/> Damaged chimney thermometer – replacement required <input type="checkbox"/> Short circuit in connection area - revise.
<p>Evaluation error of indoor thermostat</p>  <p>Red LED control indicates</p>	<p>Reading indoor thermostat error</p> 	<ul style="list-style-type: none"> <input type="checkbox"/> interference from the room thermostat due to induction of parallel power lines. <input type="checkbox"/> Improper connection of the thermostat. <input type="checkbox"/> See chap. 6.13 By changing the hydraulic scheme change function of contact T3
<p>Evaluation error of lambda sensor</p>  <p>Red LED control indicates</p>	<p>Communication error of AK4000L LAMBDA COM</p> 	<ul style="list-style-type: none"> <input type="checkbox"/> Damaged AK4000LSU module.
<p>Evaluation error of lambda sensor</p>  <p>Red LED control indicates</p>	<p>Disconnected A-supply of lambda sensor</p> 	<ul style="list-style-type: none"> <input type="checkbox"/> Wire disfunction <input type="checkbox"/> Lambda sensor error
	<p>Short circuit of A-supply for lambda sensor</p> 	<ul style="list-style-type: none"> <input type="checkbox"/> Aborted heating LS <input type="checkbox"/> Aborted power line k LS
<p>Battery status</p>  <p>Red LED control indicates</p>	<p>Discharged batteries</p> 	<ul style="list-style-type: none"> <input type="checkbox"/> Replace batteries

19. TRANSPORT, HANDLING, ASSEMBLY AND INSTALLATION

19.1 INSTRUCTIONS FOR TRANSPORT AND HANDLING

VIGAS 16,25,40 boilers are delivered on wooden legs that allow handling with a handling or forklift truck. After transport to the installation site, the feet must be dismantled and the boiler placed on a non-combustible floor. VIGAS 60,80,100 boilers are supplied on steel legs, which are part of the boiler body and cannot be dismantled. V If necessary, it is possible to use the screwing of the hanging eye into the upper threaded socket G2" (the eye is not included in the delivery of the boiler). The hanging eye can be used when handling with a crane.

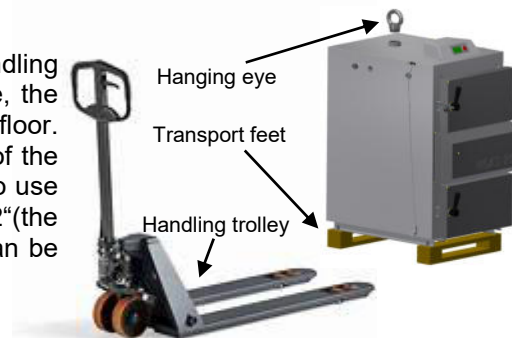

19.2 ASSEMBLY AND INSTALLATION INSTRUCTION

- Boiler can only be connected to the heating system with relevant thermal output capacity
- When using enhanced circulation, central heating system must offer option, in case of a power cut (shutdown boiler and pump) to ensure boiler minimum power at 5kW. This is provided by safety cooling exchanger together with Honeywell drain valve TS131.

Drain valve Honeywell TS 131 is additional component, it is not part of the boiler.

- In case, boiler is installed with accumulator tank, the minimum tank volume is calculated according to STN EN 303/5:2021 as follows: $V_{sp} = 15T_B \times Q_N (1 - 0,3Q_H/Q_{min})$. Minimum recommended volumes of containers for boilers VIGAS 16 VIGAS 18 DPA - 500 L boiler VIGAS 25, VIGAS UD 29 - 800 L. Boiler VIGAS 40-1000 L. Boiler VIGAS 60-1500 L. Boiler VIGAS 80, VIGAS 100 - 3000 L. Using a buffer store, extending the life of the boiler.

V_{sp} – volume of accumulator tank [L]	Q_N – nominal heating power [kW]	T_B – combustion interval [hours.]
Q_H – required boiler power - heating area [kW]	Q_{min} – minimum heating power [kW]	

- Boiler must be connected to the chimney correctly and shortest way. Chimney should not be occupied by any other devices. Chimney venting must be in accordance with STN 734201 and STN 734210.
- We do not recommend permanent connection to the water supply through inlet valve, in order to avoid increased pressure in the svstem. Maximu overpressure is 0.3 MPa.
- Boiler assembly and installation must be **carried out by authorized technician.**
- Boiler must be commisioned by authorized trained technician.**
- Boiler does not require separate solid base.
- Minimum temperature of reverse water returning to the boiler shall be 60 °C. This condition shall be secured by thermostatic or thermoregulatory valve. Recommended manufacturer is ESBE: Type VTC312 (G1") up to 40kW boiler, type VTC512 (G6/4") up to 150kW boiler performance
- Boiler room must be permanently ventilated through min. 0,025 m² slot. Diameter for inlet and outlet must be similar.
- Boiler must be installed in the basic, usual surrounding in accordance with STN 33 2000-3.
- It is advised to follow saftey and health regulations in accordance with current requirements notice no. 718/2002 Statute.
- It is strictly advise to follow required standards regarding flammability level of materials surrounding the boiler according to standard STN 73 0823:1983/z1 - Flammability degree of building materials.

19.3 ELECTRICAL EQUIPMENT CONTROL AND MAINTENANCE SAFETY REGULATIONS

The boiler operator person must follow relevant regulations and standards, as well as the following rules:

- While boiler in service, none of the following actions may be carried out.
 - DO NOT uncover the electronics, fan, thermostat.
 - DO NO change the fuse.
 - DO NOT repair damaged cables or insulation.
- Maintenance and repairs to the boiler with uncovered electrical equipment may only be done by authorized person, according to notice no. 74/1996 Statute.
- Before any interference with electrical equipment, it is necessary to unplug and disconnect power cord. Connection to power supply is only allowed after all cover panels are mounted back on the boiler.
- If any defect of electrical equipment occurs or boiler insulation is damaged, it is advised:
 - DO NOT touch any part of the boiler.
 - IMMEDIATELY unplug and disconnet the boiler from power supply.
 - TO CALL authorized technician in order to remove failure.

Except basic maintenance, it is strictly forbidden:

- To carry out any work on electrical equipment while boiler is plugged in.
- To touch defected electrical equipment, mainly damaged wire insulation, etc.
- To operate boiler while uncovered.
- To operate boiler with any defect on electrical equipment or installation.
- To repair damaged electrical parts of the boiler by person other than authorized and appointed by producer.

19.4 Recommended electric scheme with AK4000

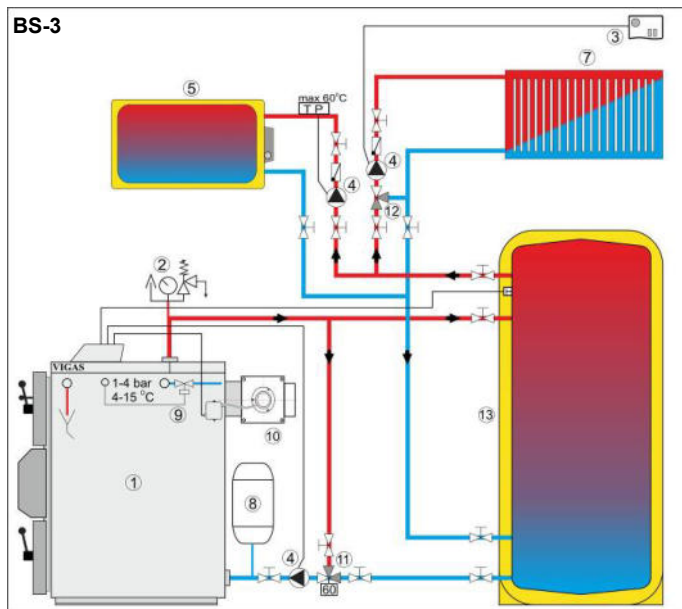
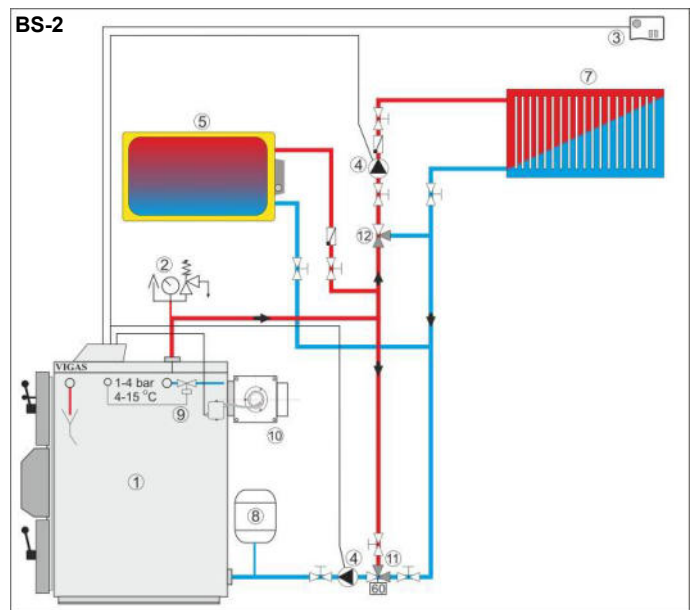
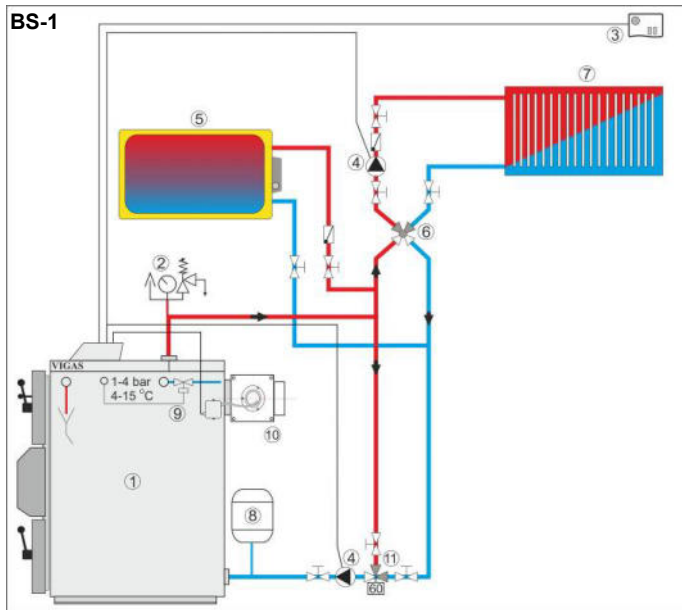

1. Boiler VIGAS
2. Security group
3. Indoor thermostat
4. Pump
5. Water tank
6. Four-way valve
7. Heating circle
8. Expansion tank
9. Safety valve Honeywell TS 131
10. Exhaust fan
11. Thermostatic valve ESBE VTC 312, VTC 511
12. Three-way mixing valve
13. Accumulation tank
M - Servo-motor
T - Thermometer KTY
TE - Thermometer - outside type KTY
TP - Pump thermostat

19.5 Recommended electric scheme with AK 4000 + Expander AK4000 Basic set.

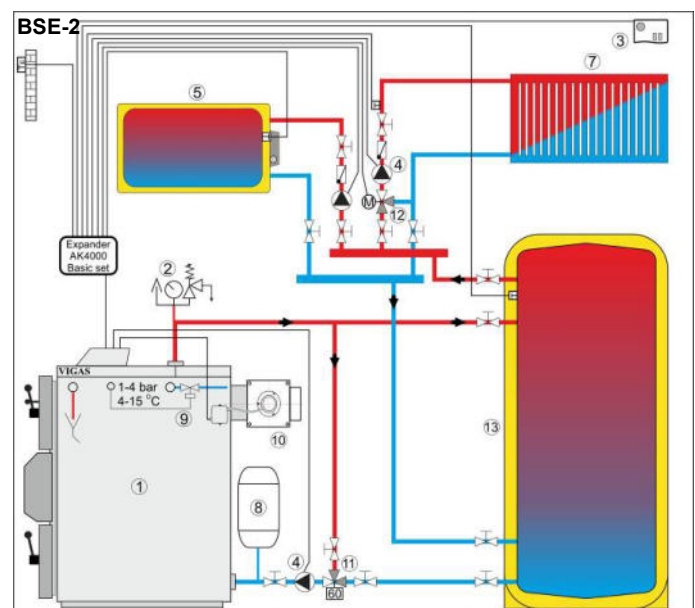
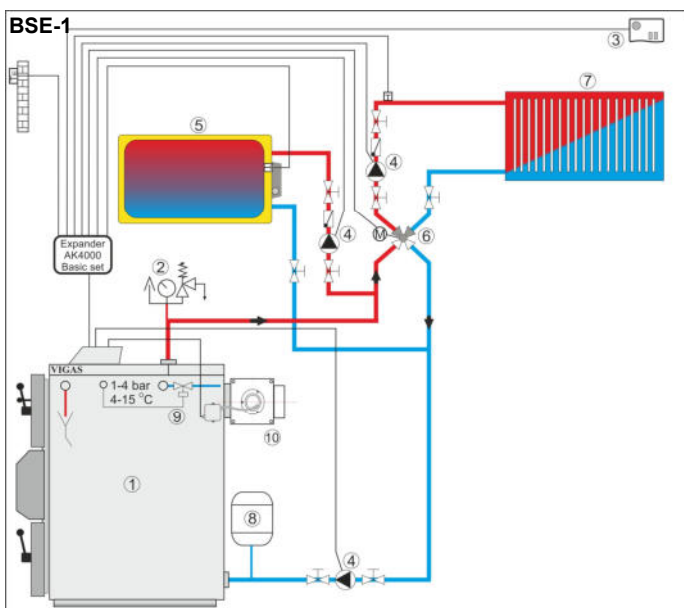

19.6 Recommended location of the boiler with determination of min. distances from walls and ceilings

VIGAS 16, 25

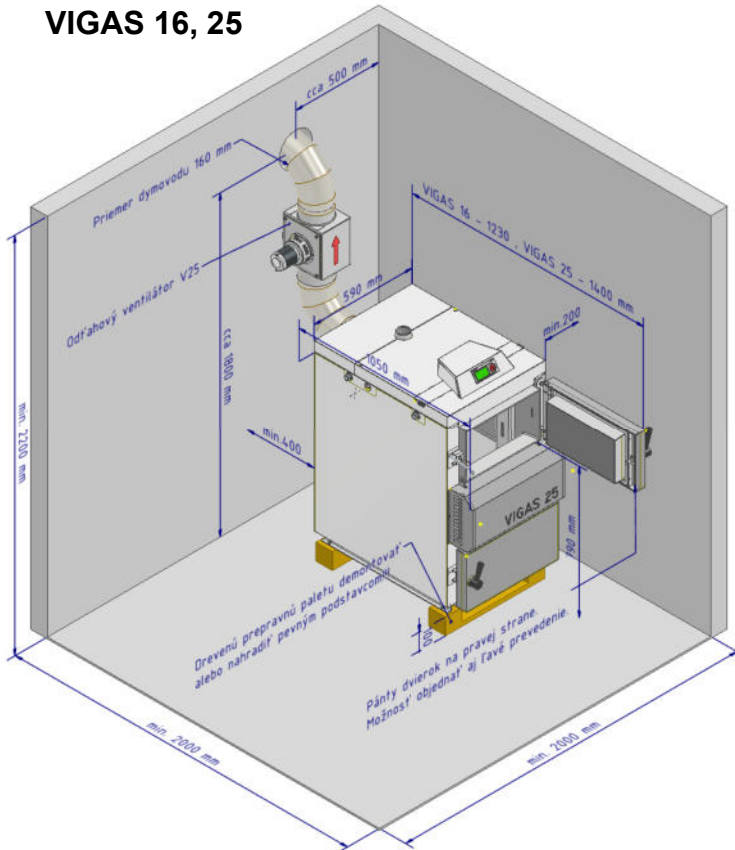

VIGAS 40

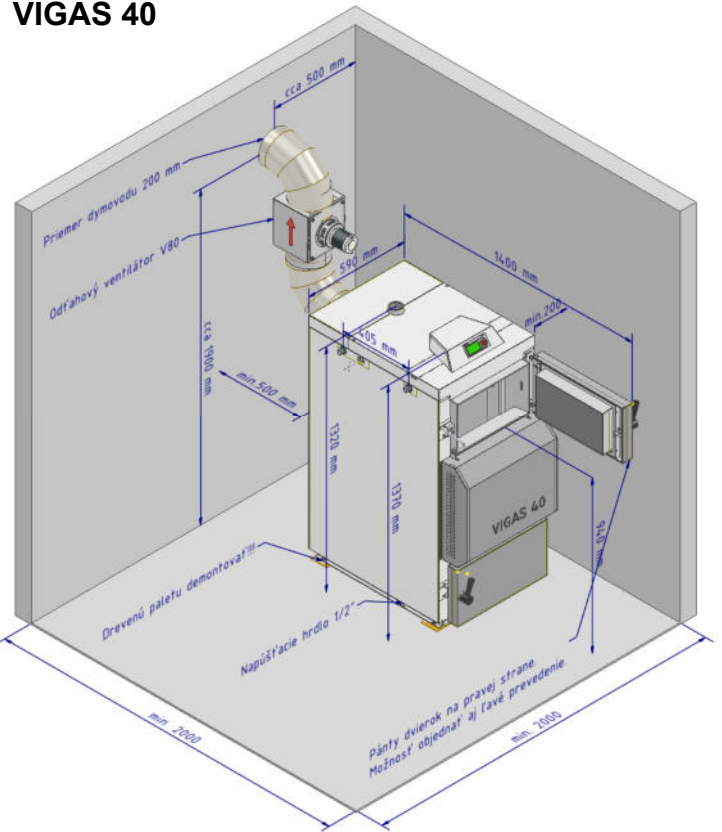

VIGAS 60,80,100

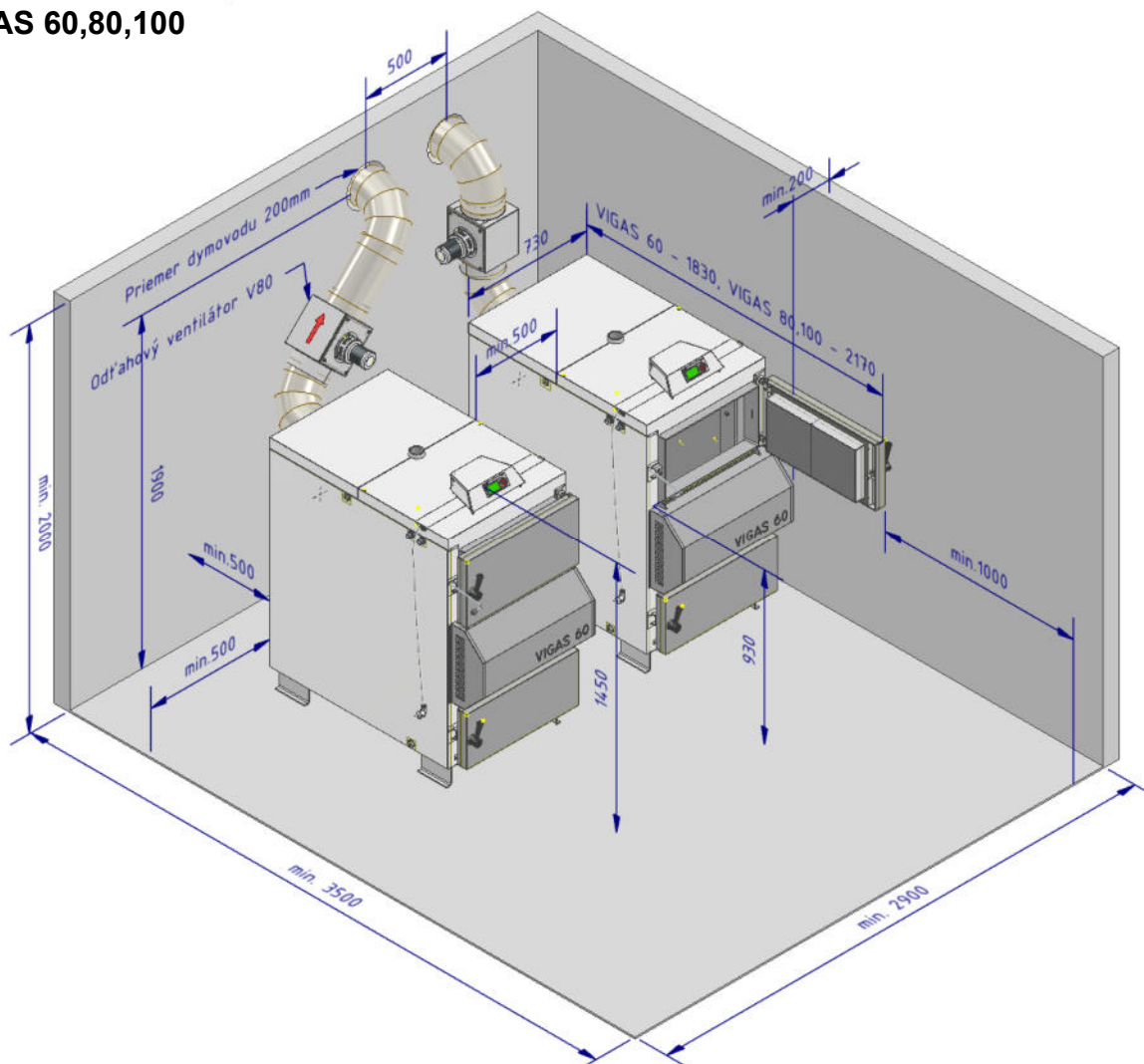

20. ELECTRIC SCHEME

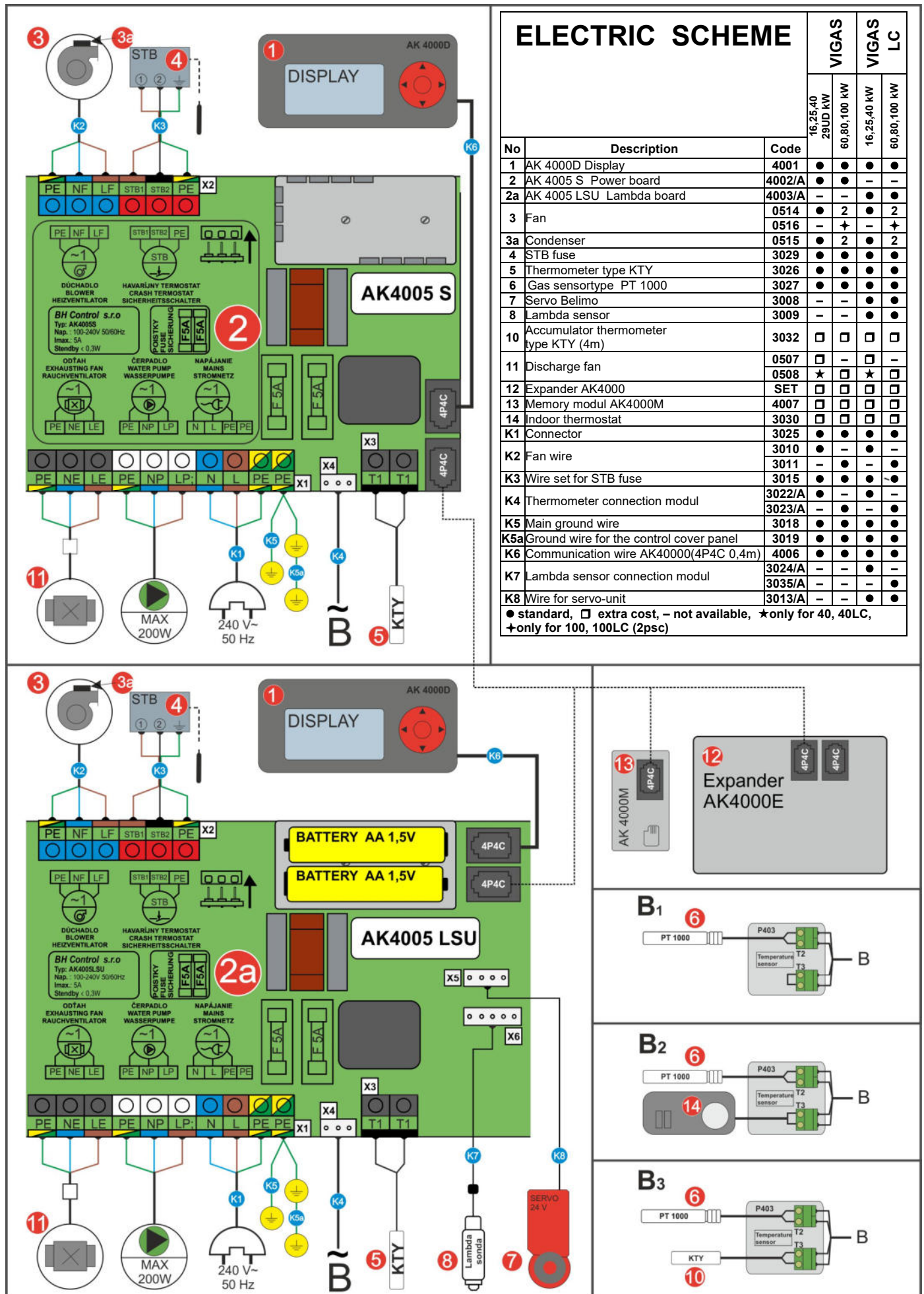

ELECTRIC SCHEME

No	Description	Code	VIGAS		VIGAS LC	
			16,25,40 29UD kW	60,80,100 kW	16,25,40 kW	60,80,100 kW
1	AK 4000D Display	4001	●	●	●	●
2	AK 4005 S Power board	4002/A	●	●	-	-
2a	AK 4005 LSU Lambda board	4003/A	-	-	●	●
3	Fan	0514	●	2	●	2
3a	Condenser	0516	-	+	-	+
4	STB fuse	3029	●	●	●	●
5	Thermometer type KTY	3026	●	●	●	●
6	Gas sensortype PT 1000	3027	●	●	●	●
7	Servo Belimo	3008	-	-	●	●
8	Lambda sensor	3009	-	-	●	●
10	Accumulator thermometer type KTY (4m)	3032	□	□	□	□
11	Discharge fan	0507	□	-	□	-
		0508	★	-	★	-
12	Expander AK4000	SET	□	□	□	□
13	Memory modul AK4000M	4007	□	□	□	□
14	Indoor thermostat	3030	□	□	□	□
K1	Connector	3025	●	●	●	●
K2	Fan wire	3010	●	-	●	-
K3	Wire set for STB fuse	3015	●	●	-	●
K4	Thermometer connection modul	3022/A	-	●	-	●
		3023/A	-	●	-	●
K5	Main ground wire	3018	●	●	●	●
K5a	Ground wire for the control cover panel	3019	●	●	●	●
K6	Communication wire AK40000(4P4C 0,4m)	4006	●	●	●	●
K7	Lambda sensor connection modul	3024/A	-	-	-	-
		3035/A	-	-	-	-
K8	Wire for servo-unit	3013/A	-	-	●	●

● standard, □ extra cost, - not available, ★ only for 40, 40LC, + only for 100, 100LC (2psc)

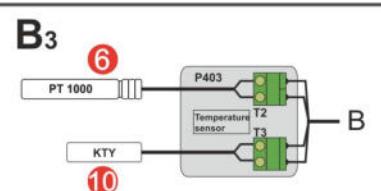
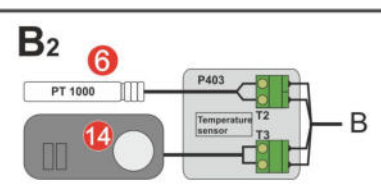
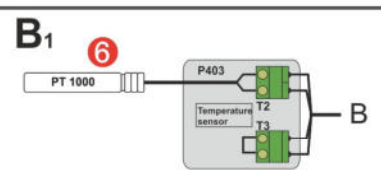
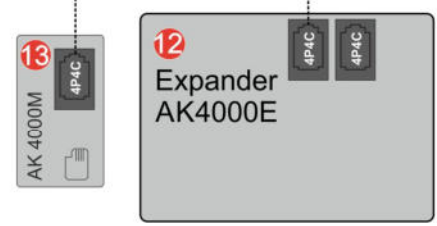

21. ANALYSIS OF RISK

RISKS DURING BOILER INSTALLATION		
SOURCE OF RISK	RISK	MEASURES TO REDUCE THE RISK
Handling the boiler to the installation site	There is a risk of injury, potential damage to boilers or the building.	<ul style="list-style-type: none"> - carefully think through and plan the handling route - choose the appropriate handling means - before handling, check the dimensions of the door openings, or modify the staircase for the passage of handling equipment - remove all obstacles that may prevent easy handling - according to the type and size of the boiler, define a space large enough for the installation of the boiler - use PPE
Boiler installation	There is a risk of injury caused by manual electric or hydraulic tools, burns.	<ul style="list-style-type: none"> - the installation of the boiler must only be carried out by a professional assembly company - move to the installation site only if necessary and very carefully, use PPE
Filling and venting of the heating system	There is a risk of overpressurization of the heating system, damage to the building's equipment and facilities.	<ul style="list-style-type: none"> - before filling the heating system, have the function of the regulating, shut-off and safety valves explained to the staff of the professional assembly company - check the marking max. operating pressure on the manometer max. (0,3MPa) - permanent connection of the filling valve with the water supply is not recommended
RISKS DURING BOILER OPERATION		
SOURCE OF RISK	RISK	MEASURES TO REDUCE THE RISK
Warming up, igniting the fuel	There is a risk of injury to hands, burns, overheating, smoke entering the boiler room	<ul style="list-style-type: none"> - when preparing fuel for heating, be extremely careful when handling tools (axe, saw) - use only prescribed fuel - check the chimney temperature max. 300°C - never use flammable substances to light the fuel (gasoline, diesel, oil and others) - keep the top door closed during lighting - use PPE, especially protective gloves
Adding fuel, checking fuel	Burns due to gas ignition, inhalation of combustion products, hand injury	<ul style="list-style-type: none"> - after opening the chimney flap, wait approx. 10 seconds for the fuel chamber to ventilate, then partially open the upper door and make sure that the chamber is sufficiently ventilated and only then fully open the door - always add and check fuel with the pressure fan switched off - never open the door suddenly!!! - add fuel only after the previous loading has finished burning, the minimum interval between adding 3 hours - in the case of installing an exhaust fan, use it to ventilate the fuel chamber - use PPE, especially protective gloves
Failure to close the door and chimney flap	There is a risk of overheating of the boiler, damage to the flue gas thermometer, lambda probe, exhaust fan, smoke entering the boiler room, hot coals falling out	<ul style="list-style-type: none"> - always check that the door and chimney flap are closed when leaving the boiler room - prepare a sufficient amount of fuel in the boiler room so that it is not necessary to leave the boiler room to refuel - install the STW safety thermostat with automatic reset RESIDEO TS 131 ¾" 95°C in order to disperse excess heat - placing a non-combustible mat in front of the boiler

Cleaning the exchanger and combustion chamber	There is a risk of injury to hands, burns, inhalation of dust particles	<ul style="list-style-type: none"> - clean the exchanger and the combustion chamber when the boiler has cooled down and is switched off, the temperature of the boiler should not be higher than 50°C - close all doors while cleaning the exchanger - only open the lower door while cleaning the combustion chamber, dig out the ash from the chamber and place it in the metal container intended for that (it may still be hot) - ensure sufficient ventilation in the boiler room - if an exhaust fan is installed, use it to remove dust particles - use the cleaning accessories supplied with the boiler - use PPE, mainly protective gloves and a respirator
A power out	There is a risk of boiler overheating during forced water circulation	<ul style="list-style-type: none"> - during a power outage, do not open the door or the chimney flap - installation of the STW safety thermostat with automatic reset RESIDEO TS 131 3/4" 95°C in order to dissipate excess heat - installation of a spare power source.

ELECTRICAL RISKS

SOURCE OF RISK	RISK	MEASURES TO REDUCE THE RISK
Fan, regulation, STB fuse, thermometers, tube fuses, cabling, their replacement or repair	Electric shock, fire, burn	<ul style="list-style-type: none"> - all electrical parts are covered so that the operator does not come into contact with them - the device is safely hidden under the cover sheets and it is impossible to get to it without the use of tools - all electrical parts are manufactured in accordance with valid regulations and EU standards - covering the sheets under which the electrical equipment is located are marked with a warning sticker - all repairs must be carried out after disconnecting the boiler from the electricity supply. networks - interference with electricity parts can only be performed by a person with the necessary authorization or authorization
Connection of pump, exhaust fan	Electric shock, damage to regulation	<ul style="list-style-type: none"> - make all connections after disconnecting the boiler from the electricity supply. networks - interference with electricity parts can only be performed by a person with the necessary authorization or authorization

THERMAL RISKS

SOURCE OF RISK	RISK	MEASURES TO REDUCE THE RISK
Door controls, controls and cover plates	There is a risk of hand injury, burns	<ul style="list-style-type: none"> - all parts are designed so that the surface temperature does not exceed the temperature according to EN ISO 13732-1 - use protective gloves
Fuel storage near the boiler	There is a risk of fire	<ul style="list-style-type: none"> - fuel storage min. 1m from the boiler - never dry fuel lying on or leaning against the boiler - have a suitable fire extinguisher in the boiler room
Chimney neck, flue, connection to the chimney body	Chimney neck, flue, connection to the chimney body	<ul style="list-style-type: none"> - never dry fuel placed or leaning against the chimney neck and flue pipe - sufficiently seal and fasten the connections so that the flue pipe does not become disconnected - have a suitable fire extinguisher in the boiler room
Ash, ash container	There is a risk of injury to hands, burns, fire	<ul style="list-style-type: none"> - always place ashes in a non-flammable, metal container (may contain hot coals) - place the container with ashes out of reach of flammable materials - use protective gloves when cleaning and handling

Gasifying boiler VIGAS

Electrical Device Connection Record (pump, discharge fan, indoor thermostat, expander, etc.)				
Date	Device	Service person name	Certificate no.	Service person signature

Warranty and after warranty repairs Records				
Date	Number of repair protocol	Service person name	Certificate no.	Service person signature

Notes

Information sheet with data on the energy consumption of products VIGAS

Commission Regulation (EU) 2015/1189, implementing Directive 2009/125/EC of the European Parliament and of the Council with regard to ecodesign requirements for solid fuel boilers, commission Regulation (EU)2015/1189 supplementing Directive 2010/30/EU of the European Parliament and of the Council with regard to energy labelling of solid fuel boilers.

Product information	Symbol	Jednotka	16	16 LC	25	25 LC	40	40 LC	60	60 LC	80	80 LC	100	100 LC
Energy efficiency class			A+	A+	A+	A+	A+	A+	A+	A+	A+	A+	A+	A+
Coefficient of energy	EEl		113	113	114	114	113	115	113	115	113	118	115	116
Seasonal Energy efficiency heating area	η_s	%	77	77	77	78	77	78	77	78	77	80	78	79
Mode stoking	manually													
Boiler is recommended to operated from a reservoir least		L	500	500	800	800	1000	1000	1500	1500	3000	3000	3000	3000
Condensing boiler														
Combined boiler														
Preferred fuel	Chopped wood ,moisture content 20%													
Characteristic when operating with preferred flue														
Useful thermal output at rated power	P _n	kW	16,04	15,01	25,06	25,97	40,20	40,56	60,65	66,71	79,33	83,01	98,00	99,30
Useful efficiency at rated power from GCV	η_n	%	81,17	82,16	81,29	82,48	79,82	82,51	81,58	82,92	81,46	82,77	82,21	83,60
Useful thermal output at minimum output /<50%	P _p	kW	6,75	7,35	8,61	7,80	14,41	14,02	26,23	22,98	33,82	31,04	41,40	39,10
Useful efficiency at minimum output from GCV	η_p	%	80,34	79,95	80,37	83,36	79,88	81,38	79,71	81,47	79,95	8358	81,05	81,96
Own electricity consumption at rated power	el _{max}	kW	0,014	0,025	0,022	0,033	0,034	0,045	0,049	0,060	0,062	0,073	0,142	0,154
Own electricity at minimum output	el _{min}	kW	0,003	0,003	0,005	0,016	0,005	0,016	0,009	0,020	0,009	0,020	0,012	0,023
Own electricity consumption in standby mode	PSB	kW	0,001	0,001	0,001	0,001	0,001	0,001	0,001	0,001	0,001	0,001	0,001	0,001
Season emissions of the heating space TC ¹⁾	PM	mg/m ³	18	19	16	14	27	22	18	13	17	14	16	16
Season emissions of the heating space OGC ¹⁾	OGC	mg/m ³	28	26	25	15	29	20	22	19	23	20	23	21
Season emissions of the heating space CO ¹⁾	CO	mg/m ³	536	530	366	323	410	246	445	451	402	423	358	359
Season emissions of the heating space NOx ¹⁾	NOx	mg/m ³	148	150	176	165	169	166	148	146	149	147	151	148

1) Preferred fuel: Chopped wood, moisture content 20%

LETTER OF WARRANTY

Certificate of Quality and Completion

Product

VIGAS

kW

Serial number :

The manufacturer confirms that the boiler complies with standards, STN EN 303-5+A1 2023, STN EN 61010-1:2004-02, STN EN 61000-6-3:2003-10, STN EN 50082-1:2002, STN EN 61000-6-3:2007, STN EN IEC 61000-6-2:2020, STN EN 60335-2-102:2016, STN EN 60335-1:2012, STN EN ISO 9606-1:2018, STN EN ISO 14120:2017, STN EN 14597:2012.

Production inspection day

.....
Stamp and signature of manufacturer

Date of purchase

Date of commission

.....
Stamp and signature of seller



VIGAS commission certificate

Product

VIGAS

kW

Serial number

Date of purchase

Date of commission

.....
Stamp and signature of dealer

.....
Signature of heating specialist

User name and address :

Instructions and warranty conditions for customers:

- Claims regarding the completion of delivery must be in accordance with Commercial Code and Civil Code of the supplier.
- Damage and defects during transportation must be claimed by the customer to the carrier at the time of delivery.
- Warranty period is 24 month from the date of sale.
- The warranty is valid only if the boiler is commissioned by an authorised technician.
- The warranty is valid only if the electric equipment is connected according to regulation only by a trained specialist and recorded in relevant documents.
- The warranty applies to manufacturer product only.

Warranty does not apply to:

- Consumer material: gaskets, exchanger seal, under fan seal, heatproof nozzle, heatproof filling, fireclay bricks
- Defects caused by customer
- Defects caused by incorrect assembly, operation and maintenance, unauthorised handling or if the product is used for any other purpose than that specified by the manufacturer
- To claim warranty the relevant provisions of the civil code.

The manufacturer reserves the right to make changes within the framework of the product innovation.



Following operations were performed during commissioning

- Boiler maintenance and service explained to customer
- Boiler tuition before fire
- Burning test in the boiler
- Confirm and complete data in the warranty document

.....
Owner of the boiler - signature

Notes:



Serial number



Gasifying boiler VIGAS

MANUFACTURER:

VIMAR Vigaš Pavel

M. Čulena 25

974 11 Banská Bystrica

SLOVAKIA

tel.: 00421 48 4187 022

www.vigas.eu, vimar@vimar.sk

DISTRIBUTOR:

